

# Test Report

Report No.: RKEYS250731242

Date: Aug.13, 2025

Page 1 of 55

## CE RED EMC

For

**Product: Wireless Charger**

**Model: MO2651**

**Report No.: RKEYS250731242**

Issued for

**Mid Ocean Brands B.V.**

**Unit 711-716, 7/F., Tower A, 83 King Lam Street, Cheung Sha Wan, Kowloon, Hong Kong.**

Issued by

**Guangdong KEYS Testing Technology Co.,Ltd.**

**Address: Building 1, No.18, Shihuan Road, Dongcheng Subdistrict, Dongguan, Guangdong, China**



Scan to view  
the original file

**Guangdong KEYS Testing Technology Co., Ltd.**

Address: Building 1, No.18, Shihuan Road, Dongcheng Subdistrict, Dongguan, Guangdong, China

Tel: +86-0769-22221088 <http://www.keys-lab.com> E-mail: [info@keys-lab.com](mailto:info@keys-lab.com)

This report is only responsible for the test results of the samples submitted for inspection, and is not responsible for the source of the samples submitted for inspection. This report shall not be altered, increased or deleted. Without written approval of KEYS, this test report shall not be copied except in full and published as advertisement.

# Test Report

Report No.: RKEYS250731242

Date: Aug.13, 2025

Page 2 of 55

## TABLE OF CONTENTS

<b>1. TEST CERTIFICATION .....</b>	<b>3</b>
<b>2. TEST SUMMARY .....</b>	<b>4</b>
<b>3. TEST SITE .....</b>	<b>5</b>
3.1. TEST FACILITY .....	5
3.2. MEASUREMENT UNCERTAINTY .....	5
3.3. LIST OF TEST AND MEASUREMENT INSTRUMENTS .....	5
<b>4. EUT DESCRIPTION .....</b>	<b>10</b>
<b>5. TEST METHODOLOGY .....</b>	<b>11</b>
5.1. TEST MODE .....	11
5.2. EUT SYSTEM OPERATION .....	11
<b>6. SETUP OF EQUIPMENT UNDER TEST .....</b>	<b>12</b>
6.1. DESCRIPTION OF SUPPORT UNITS .....	12
6.2. CONFIGURATION OF SYSTEM UNDER TEST .....	12
<b>7. EMISSION TEST .....</b>	<b>13</b>
7.1. CONDUCTED EMISSION MEASUREMENT .....	13
7.2. RADIATED EMISSION MEASUREMENT .....	14
7.3. RADIATED EMISSION MEASUREMENT (ABOVE 1GHz) .....	22
7.4. HARMONICS CURRENT MEASUREMENT .....	26
7.5. VOLTAGE FLUCTUATION AND FLICKS MEASUREMENT .....	28
<b>8. IMMUNITY TEST .....</b>	<b>30</b>
8.1. ELECTROSTATIC DISCHARGE (ESD) .....	32
8.2. RADIATED, RADIO-FREQUENCY, ELECTROMAGNETIC FIELD (RS) .....	36
8.3. ELECTRICAL FAST TRANSIENT (EFT) .....	39
8.4. SURGE IMMUNITY TEST .....	41
8.5. CONDUCTED RADIO FREQUENCY DISTURBANCES (CS) .....	43
8.6. POWER FREQUENCY MAGNETIC FIELD .....	45
8.7. VOLTAGE DIP & VOLTAGE INTERRUPTIONS .....	48
<b>9. PHOTOGRAPHS OF THE TEST CONFIGURATION .....</b>	<b>51</b>
<b>10. PHOTOGRAPHS OF EUT .....</b>	<b>53</b>

# Test Report

Report No.: RKEYS250731242

Date: Aug.13, 2025

Page 3 of 55

## 1. TEST CERTIFICATION

Product: Wireless Charger

Trade mark: N/A

Model: MO2651

Applicant : Mid Ocean Brands B.V.

Address: Unit 711-716, 7/F., Tower A, 83 King Lam Street, Cheung Sha Wan, Kowloon, Hong Kong.

Manufacturer: 117486

Address: N/A

Sample Received Date: Jul.31, 2025

Test Date: Jul.31, 2025 to Aug.05, 2025

Power supply: Model: MOB/MO2651  
Input: DC 9V 2A, 5V 2A  
Output: DC 5V 1A, 7.5V 1A, 9V 1.1A, 9V 1.67A

Applicable Standards: ETSI EN 301 489-1 V2.2.3 (2019-11)  
ETSI EN 301 489-3 V2.2.1 (2019-03)

The above equipment has been tested by Guangdong KEYS Testing Technology Co., Ltd. and found compliance with the requirements in the technical standards mentioned above. The test results presented in this report only relate to the product/system tested. The Other similar equipment will not necessarily produce the same results due to production tolerance and measurement uncertainties.

Prepared by:

*Linda Chen*

Linda Chen / Engineer

Approved by:

*Bruce Zhang*  
Bruce Zhang / Manager

# Test Report

Report No.: RKEYS250731242

Date: Aug.13, 2025

Page 4 of 55

## 2. TEST SUMMARY

EMISSION			
Standard	Item	Result	Remarks
EN 55032:2015	Conducted emission (Mains Port)	PASS	Complied with limit
	Radiated emission	PASS	Complied with limit
EN IEC 61000-3-2:2019+A1:2021	Harmonic current emissions	N/A	Not Applicable
EN 61000-3-3:2013/A2:2021/ AC:2022-01	Voltage fluctuations & flicker	N/A	Not Applicable

IMMUNITY			
Standard	Item	Result	Remarks
EN 61000-4-2	ESD	PASS	Complied with the requirements
EN 61000-4-3	RS	PASS	Complied with the requirements
EN 61000-4-4	EFT	N/A	Not Applicable
EN 61000-4-5	Surge	N/A	Not Applicable
EN 61000-4-6	CS	N/A	Not Applicable
EN 61000-4-8	PFMF	N/A	Not Applicable
EN 61000-4-11	Voltage dips & voltage variations	N/A	Not Applicable

Note: 1) The test result verdict is decided by the limit of test standard

2)Not Applicable: The EUT is powered by DC.

# Test Report

Report No.: RKEYS250731242

Date: Aug.13, 2025

Page 5 of 55

## 3. TEST SITE

### 3.1. TEST FACILITY

Guangdong KEYS Testing Technology Co., Ltd.

Address: Building 1, No.18, Shihuan Road, Dongcheng Subdistrict, Dongguan, Guangdong, China

### 3.2. MEASUREMENT UNCERTAINTY

Parameter	Uncertainty
Temperature	±1°C
Humidity	±5%
DC and Low Frequency Voltages	±3%
Conducted Emission(150KHz-30MHz)	±3.60dB
Radiated Emission(30MHz-1GHz)	±4.76dB
Radiated Emission (1GHz-18GHz)	±4.44dB

Note 1: This uncertainty represents an expanded uncertainty expressed at approximately the 95% confidence level using a coverage factor of k=2.

### 3.3. LIST OF TEST AND MEASUREMENT INSTRUMENTS

#### 3.3.1 For conducted emission at the mains terminals test

Name of Equipment	Manufacturer	Model	Equipment No.	Serial No.	Last Cal.	Cal. Interval
EMI Test Receiver	Rohde&Schwarz	ESCI	KEYS-EL-203	1166.5950.03-101142	Mar. 03, 2025	1 Year
Pulse Limiter	Rohde&Schwarz	ESH3-Z2	KEYS-EL-201	0357.8810.54-101857-hz	Mar. 03, 2025	1 Year
LISN	Rohde&Schwarz	ENV216	KEYS-EL-202	3560.6550.12-103020-YU	Mar. 03, 2025	1 Year
Test software	Tonscend	JS32-CE Version 5.0.0				

**Guangdong KEYS Testing Technology Co., Ltd.**

Address: Building 1, No.18, Shihuan Road, Dongcheng Subdistrict, Dongguan, Guangdong, China  
 Tel: +86-0769-22221088 <http://www.keys-lab.com> E-mail: [info@keys-lab.com](mailto:info@keys-lab.com)

This report is only responsible for the test results of the samples submitted for inspection, and is not responsible for the source of the samples submitted for inspection. This report shall not be altered, increased or deleted. Without written approval of KEYS, this test report shall not be copied except in full and published as advertisement.

# Test Report

Report No.: RKEYS250731242

Date: Aug.13, 2025

Page 6 of 55

### 3.3.2. For radiated emission test (30MHz-1GHz)

Name of Equipment	Manufacturer	Model	Equipment No..	Serial No.	Last Cal.	Cal. Interval
EMI Test Receiver	Rohde&Schwarz	ESCI7	KEYS-EL-205	1166.5950.03-100633	Mar. 03, 2025	1 Year
Logarithmic periodic antenna	Schwarzbeck	VULB9168	KEYS-EL-209	01145	Mar. 06, 2025	3 Year
Preamplifier	HP	8447F	KEYS-EL-210	1-18-53G22	Mar. 03, 2025	1 Year
3m Anechoic Chamber	Taihe MaoRui	9*6*6	KEYS-EL-234	/	Oct. 09, 2024	5 Year
Test software	Tonscend	JS32-RE Version 5.0.0				

### 3.3.3. For radiated emission test (1GHz above)

Name of Equipment	Manufacturer	Model	Equipment No.	Serial No.	Last Cal.	Cal. Interval
EMI Test Receiver	Rohde&Schwarz	ESCI 7	KEYS-EL-205	1166.5950.03-100633	Mar. 03, 2025	1 Year
Horn antenna	Schwarzbeck	BBHA9120D	KEYS-EL-239	03083	Mar. 06, 2025	3 Year
Preamplifier	/	1-18-53G22	KEYS-EL-240	2501020026	Mar. 03, 2025	1 Year
Test software	Tonscend	JS32-RE Version 5.0.0				

# Test Report

Report No.: RKEYS250731242

Date: Aug.13, 2025

Page 7 of 55

### 3.3.4. For harmonic current emissions and voltage fluctuations/flicker test

Name of Equipment	Manufacturer	Model	Equipment No.	Serial No.	Last Cal.	Cal. Interval
AC Power Source	California instruments	5001i-400	KEYS-EL-248	55979	May 17, 2025	1 Year
Harmonic and Flicker Analyzer	California instruments	PACS-1	KEYS-EL-249	72145	May 17, 2025	1 Year
Test software	California Instruments	CTS 4 Version 4.32.0				

### 3.3.5. For electrostatic discharge immunity test

Name of Equipment	Manufacturer	Model	Equipment No.	Serial No.	Last Cal.	Cal. Interval
ESD Tester	PRIMA	ESD6100 2TB	KEYS-EL-215	PR9240625796	Mar. 05, 2025	1 Year

### 3.3.6. For radio frequency electromagnetic field immunity (R/S) test

Name of Equipment	Manufacturer	Model	Equipment No.	Serial No.	Last Cal.	Cal. Interval
Amplifier	Micotop	MPA-80-1000-250	KEYS-EL-258	MAP2503096	May 17, 2025	1 Year
Amplifier	Micotop	MPA-1000-6000-100	KEYS-EL-259	MPA2503098	May 19, 2025	1 Year
Power Meter	Agilent	E4417A	KEYS-EL-260	GB41293356	May 17, 2025	1 Year
Power Sensor	Agilent	E9304A	KEYS-EL-261	MY55200008	May 17, 2025	1 Year
Power Sensor	Agilent	E9304A	KEYS-EL-262	MY55200004	May 17, 2025	1 Year
Signal Generator	ROHDE&SCHWARZ	SMB100A	KEYS-EL-263	102913	May 17, 2025	1 Year
Log-Per-Broadband Antenna	SKET	STLP 9129 PLUS	KEYS-EL-264	/	May 19, 2025	3 Year
Audio Analyzer	ROHDE&SCHWARZ	UPP200	KEYS-EL-267	120175	May 17, 2025	1 Year

**Guangdong KEYS Testing Technology Co., Ltd.**

Address: Building 1, No.18, Shihuan Road, Dongcheng Subdistrict, Dongguan, Guangdong, China  
 Tel: +86-0769-22221088 <http://www.keys-lab.com> E-mail: [info@keys-lab.com](mailto:info@keys-lab.com)

This report is only responsible for the test results of the samples submitted for inspection, and is not responsible for the source of the samples submitted for inspection. This report shall not be altered, increased or deleted. Without written approval of KEYS, this test report shall not be copied except in full and published as advertisement.

# Test Report

Report No.: RKEYS250731242

Date: Aug.13, 2025

Page 8 of 55

### 3.3.7. For electrical fast transient/burst immunity test

Name of Equipment	Manufacturer	Model	Equipment No.	Serial No.	Last Cal.	Cal. Interval
Fast Transient Burst Simulator	PRIMA	EFT61004TA	KEYS-EL-218	PR9240743972	Mar. 03, 2025	1 Year
Clamp	PRIMA	PEFT-C105	KEYS-EL-219	PEFT-1170	Mar. 03, 2025	1 Year

### 3.3.8. For surge immunity test

Name of Equipment	Manufacturer	Model	Equipment No.	Serial No.	Last Cal.	Cal. Interval
Lighting Surge Generator	PRIMA	SUG61005TB-2216	KEYS-EL-217	PR200854619	Mar. 03, 2025	1 Year
Coupling/Decoupling Network	PRIMA	SUG-CDN-108	KEYS-EL-216	PR924105429	Mar. 03, 2025	1 Year

### 3.3.9. For injected currents susceptibility test

Name of Equipment	Manufacturer	Model	Equipment No.	Serial No.	Last Cal.	Cal. Interval
CS Test system	TESEQ	NSG4070	KEYS-EL-255	30608	May 17, 2025	1 Year
6dB Attenuator	TESEQ	ATN6075	KEYS-EL-256	30783	May 17, 2025	1 Year
CDN	TESEQ	CDN M016	KEYS-EL-254	33518	May 17, 2025	1 Year
EM-Clamp	TESEQ	KEMZ 801A	KEYS-EL-257	33425	May 17, 2025	1 Year



# Test Report

Report No.: RKEYS250731242

Date: Aug.13, 2025

Page 9 of 55

3.3.10.  For power frequency magnetic field immunity test

Name of Equipment	Manufacturer	Model	Equipment NO.	Serial No.	Last Cal.	Cal. Interval
POWER FREQUENCY MAGNETIC FIELD GENERATION	EVERFINE	EMS61000-8 K	KEYS-EL-273	608002	May 16, 2025	1 Year

3.3.11.  For voltage dips and short interruptions immunity test

Name of Equipment	Manufacturer	Model	Equipment No.	Serial No.	Last Cal.	Cal. Interval
Cycle Sag Simulator	PRIMA	DRP61011TB	KEYS-EL-220	PR924086817	Mar. 03, 2025	1 Year

Note:

The test equipment corresponds to the test items. (The selected checkbox indicates that the equipment has been used during testing, while the unselected one indicates that the equipment has not been used.)

# Test Report

Report No.: RKEYS250731242

Date: Aug.13, 2025

Page 10 of 55

## 4. EUT DESCRIPTION

<b>Product</b>	Wireless Charger
<b>Model</b>	MO2651
<b>RF Specification</b>	110-205kHz
<b>Supplied Voltage</b>	Model: MOB/MO2651 Input: DC 9V 2A, 5V 2A Output: DC 5V 1A, 7.5V 1A, 9V 1.1A, 9V 1.67A

## I/O PORT

I/O PORT TYPES	Q'TY	TESTED WITH
AC Port	1	<input type="checkbox"/>
DC Port	1	<input checked="" type="checkbox"/>

## Models Difference

N/A

# Test Report

Report No.: RKEYS250731242

Date: Aug.13, 2025

Page 11 of 55

## 5. TEST METHODOLOGY

### 5.1. TEST MODE

The EUT was tested together with the thereafter additional components, and a configuration, which produced the worst emission levels, was selected and recorded in this report.

Test Mode 1	110-205kHz Link
Test Mode 2	idle

The following test mode(s) were assessed.

	Test Items	Test Mode
Emission	Conducted Emission	All mode
	Radiated Emission	All mode
	Radiated Emission above 1GHz	All mode
	Harmonic current emissions	N/A
	Voltage fluctuations & flicker	N/A
Immunity	ESD	All mode
	RS	All mode
	EFT	N/A
	Surge	N/A
	C/S	N/A
	PFMF	N/A
	Dips	N/A

Note: Only the worse mode was record in this report.

### 5.2. EUT SYSTEM OPERATION

1. Set up EUT with the support equipment.
2. Make sure the EUT work normally during the test.

# Test Report

Report No.: RKEYS250731242

Date: Aug.13, 2025

Page 12 of 55

## 6. SETUP OF EQUIPMENT UNDER TEST

### 6.1. DESCRIPTION OF SUPPORT UNITS

The EUT has been tested as an independent unit together with other necessary accessories or support units. The following support units or accessories were used to form a representative test configuration during the tests.

No.	Equipment	Model	Manufacturer	Description
1.	N/A	N/A	N/A	N/A

Note: 1) All the equipment/cables were placed in the worst-case configuration to maximize the emission during the test.

2) Grounding was established in accordance with the manufacturer's requirements and conditions for the intended use.

### 6.2. CONFIGURATION OF SYSTEM UNDER TEST

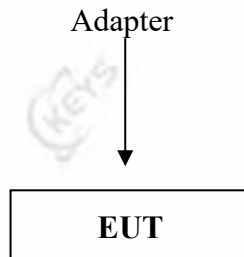

(EUT: Wireless Charger)

# Test Report

Report No.: RKEYS250731242

Date: Aug.13, 2025

Page 13 of 55

## 7. EMISSION TEST

### 7.1. CONDUCTED EMISSION MEASUREMENT

#### 7.1.1. LIMIT

FREQUENCY (MHz)	Class A		Class B	
	Quasi-peak dB(μV)	Average dB(μV)	Quasi-peak dB(μV)	Average dB(μV)
0.15 - 0.5	79	66	66-56	56-46
0.5 - 5.0	73	60	56	46
5.0 - 30.0	73	60	60	50

Note: 1) The lower limit shall apply at the transition frequencies.

2) The limit decreases in line with the logarithm of the frequency in the range of 0.15 MHz to 0.5 MHz

#### 7.1.2. TEST PROCEDURE

The EUT and Support equipment, if needed, was set up as per the test configuration to simulate typical usage per the user's manual. When the EUT is a tabletop system, a wooden table with a height of 0.8 meters is used and is placed on the ground plane. When the EUT is floor standing equipment, it is placed on the ground plane, which has a 3-12 mm non-conductive covering to insulate the EUT from the ground plane. The EUT should be 0.8 m apart from the AMN, where the mains cable supplied by the manufacturer is longer than 0.8 m, the excess should be folded at the centre into a bundle no longer than 0.4 m, Details please refer to test setup photography.

The Receiver scanned from 9 kHz to 30 MHz for emissions in each of the test modes.

During the above scans, the emissions were maximized by cable manipulation.

A scanning was taken on the power lines, Line and neutral, recording at least six highest emissions. Emission frequency and amplitude were recorded into a computer in which correction factors were used to calculate the emission level and compare reading to the applicable limit. The test data of the worst-case condition(s) was recorded.

# Test Report

Report No.: RKEYS250731242

Date: Aug.13, 2025

Page 14 of 55

## 7.1.3. TEST SETUP

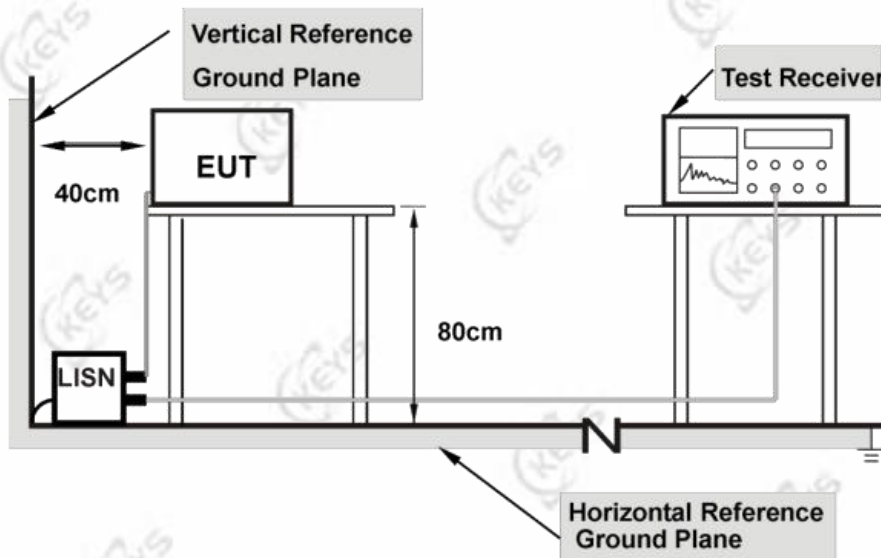

Note: 1.Support units were connected to second LISN.

2.Both of LISNs(AMN) are 80 cm from EUT and at least 80 from other units and other metal planes

## 7.1.4. TEST RESULT

<b>Product name</b>	Wireless Charger	<b>Tested By</b>	Joy Jiang
<b>Model</b>	MO2651	<b>Detector Function</b>	Quasi-peak/AV
<b>Test Mode</b>	Mode 1	<b>6 dB Bandwidth</b>	9 kHz
<b>Environmental Conditions</b>	24.3°C,53% RH, 101.1 kPa	<b>Test Result</b>	Pass

Note:

L = Line Line, N = Neutral Line

Freq. = Emission frequency in MHz

Reading level (dBμV) = Receiver reading

Corr. Factor (dB) = attenuator + Cable loss

Level (dBμV) = Reading level (dBμV) + Corr. Factor (dB)

Limit (dBμV) = Limit stated in standard

Over Limit (dB) = Level (dBμV) – Limit (dBμV)

QP = Quasi-Peak

AV = Average

**Guangdong KEYS Testing Technology Co., Ltd.**

Address: Building 1, No.18, Shihuan Road, Dongcheng Subdistrict, Dongguan, Guangdong, China

Tel: +86-0769-22221088 <http://www.keys-lab.com> E-mail: [info@keys-lab.com](mailto:info@keys-lab.com)

This report is only responsible for the test results of the samples submitted for inspection, and is not responsible for the source of the samples submitted for inspection. This report shall not be altered, increased or deleted. Without written approval of KEYS, this test report shall not be copied except in full and published as advertisement.

# Test Report

Report No.: RKEYS250731242

Date: Aug.13, 2025

Page 15 of 55

Please refer to the following diagram:

Line:

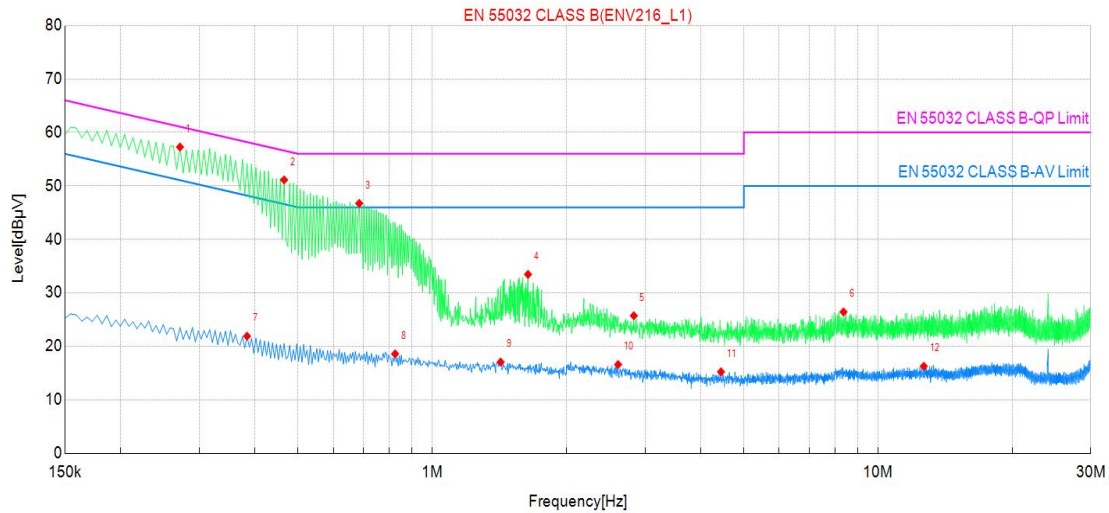

Suspected Data List									
NO.	Frequency [MHz]	Reading [dBµV]	Level [dBµV]	Factor [dB]	Limit [dBµV]	Margin [dB]	Phase	Detector	Verdict
1	0.271500	37.27	57.27	20.00	61.15	3.88	ENV21	QP	PASS
2	0.465000	31.12	51.12	20.00	56.67	5.55	ENV21	QP	PASS
3	0.685500	26.73	46.73	20.00	56.00	9.27	ENV21	QP	PASS
4	1.639500	13.45	33.45	20.00	56.00	22.55	ENV21	QP	PASS
5	2.832000	5.73	25.73	20.00	56.00	30.27	ENV21	QP	PASS
6	8.367000	6.43	26.43	20.00	60.00	33.57	ENV21	QP	PASS
7	0.384000	1.91	21.91	20.00	48.26	26.35	ENV21	AV	PASS
8	0.825000	-1.41	18.59	20.00	46.00	27.41	ENV21	AV	PASS
9	1.423500	-2.94	17.06	20.00	46.00	28.94	ENV21	AV	PASS
10	2.611500	-3.40	16.60	20.00	46.00	29.40	ENV21	AV	PASS
11	4.443000	-4.76	15.24	20.00	46.00	30.76	ENV21	AV	PASS
12	12.669000	-3.72	16.28	20.00	50.00	33.72	ENV21	AV	PASS

Note:(1)Level=Reading+Factor

(2)Margin=Limit-Level

# Test Report

Report No.: RKEYS250731242

Date: Aug.13, 2025

Page 16 of 55

Neutral:

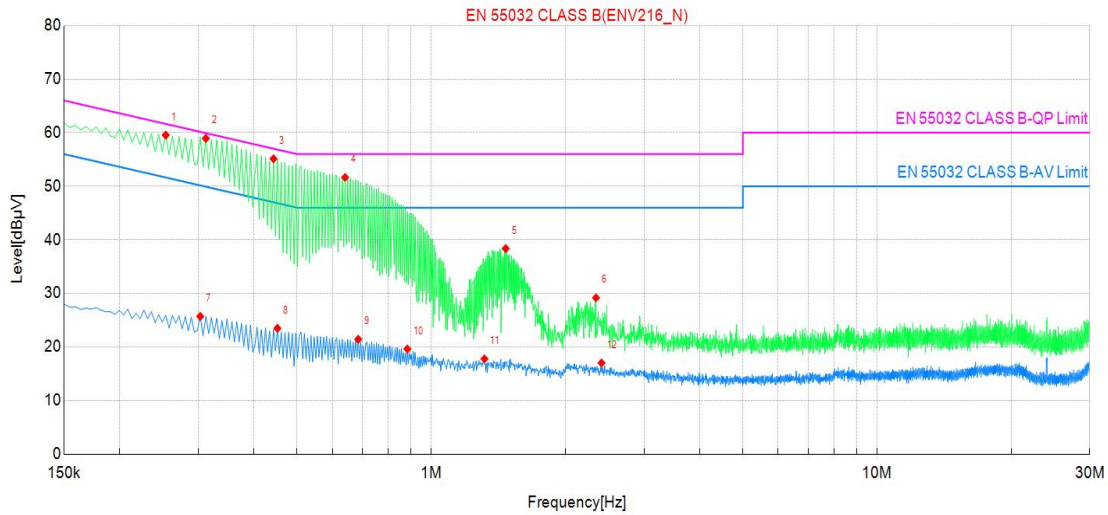

Suspected Data List									
NO.	Frequency [MHz]	Reading [dBµV]	Level [dBµV]	Factor [dB]	Limit [dBµV]	Margin [dB]	Phase	Detector	Verdict
1	0.253500	39.54	59.54	20.00	61.64	2.10	ENV21	QP	PASS
2	0.312000	38.93	58.93	20.00	59.92	0.99	ENV21	QP	PASS
3	0.442500	35.13	55.13	20.00	57.01	1.88	ENV21	QP	PASS
4	0.640500	31.65	51.65	20.00	56.00	4.35	ENV21	QP	PASS
5	1.468500	18.37	38.37	20.00	56.00	17.63	ENV21	QP	PASS
6	2.341500	9.17	29.17	20.00	56.00	26.83	ENV21	QP	PASS
7	0.303000	5.71	25.71	20.00	50.16	24.45	ENV21	AV	PASS
8	0.451500	3.49	23.49	20.00	46.85	23.36	ENV21	AV	PASS
9	0.685500	1.43	21.43	20.00	46.00	24.57	ENV21	AV	PASS
10	0.883500	-0.38	19.62	20.00	46.00	26.38	ENV21	AV	PASS
11	1.315500	-2.24	17.76	20.00	46.00	28.24	ENV21	AV	PASS
12	2.409000	-2.99	17.01	20.00	46.00	28.99	ENV21	AV	PASS

+

Note: (1) Level = Reading + Factor

(2) Margin = Limit - Level



# Test Report

Report No.: RKEYS250731242

Date: Aug.13, 2025

Page 17 of 55

## 7.2. RADIATED EMISSION MEASUREMENT

### 7.2.1. LIMITS

FREQUENCY (MHz)	Distance m	Quasi Peak dB( $\mu$ V/m)
30~230	3	40
230~1000	3	47

Note: 1) The lower limit shall apply at the transition frequencies.

2) Emission level (dB $\mu$ V/m) = 20 log Emission level ( $\mu$ V/m).

### 7.2.2. TEST PROCEDURE

- The EUT was placed on the top of an insulating table 0.8 meters above the ground at a semi-anechoic chamber. The table was rotated 360 degrees to determine the position of the highest radiation.
- The EUT was set 3 meters away from the interference-receiving antenna, which was mounted on the top of a variable-height antenna tower.
- The antenna is a broadband antenna, and its height is varied from 1 to 4 meter above the ground to determine the maximum value of the field strength. Both horizontal and vertical polarization of the antenna are set to make the measurement.
- For each suspected emission, the EUT was arranged to its worst case and then the antenna was tuned to the heights from 1 to 4 meters and the ratable table was turned from 0 degrees to 360 degrees to find the maximum reading.
- The test-receiver system was set to Peak Detector Function and Specified Bandwidth with Maximum Hold Mode when the test frequency is below 1GHz.

#### Note:

1.The resolution bandwidth of test receiver/spectrum analyzer is 120khz for quasi-peak detection(QP) at frequency below 1GHz.

2.Emission level(dB $\mu$ V/m)=Raw Value(dB $\mu$ V)+Correction Factor(dB/m)

3.Correction Factor(dB/m)=Antenna Factor(dB/m)+ Correction Factor(dB)(if the raw value not contains the amplifier);

4. Correction Factor(dB/m)=Antenna Factor(dB/m)+ Correction Factor(dB)-Amplifer Gain(dB)(if the raw value contains the amplifier).

5.Margin value=Emission level-Limit value.

# Test Report

## 7.2.3. TEST SETUP

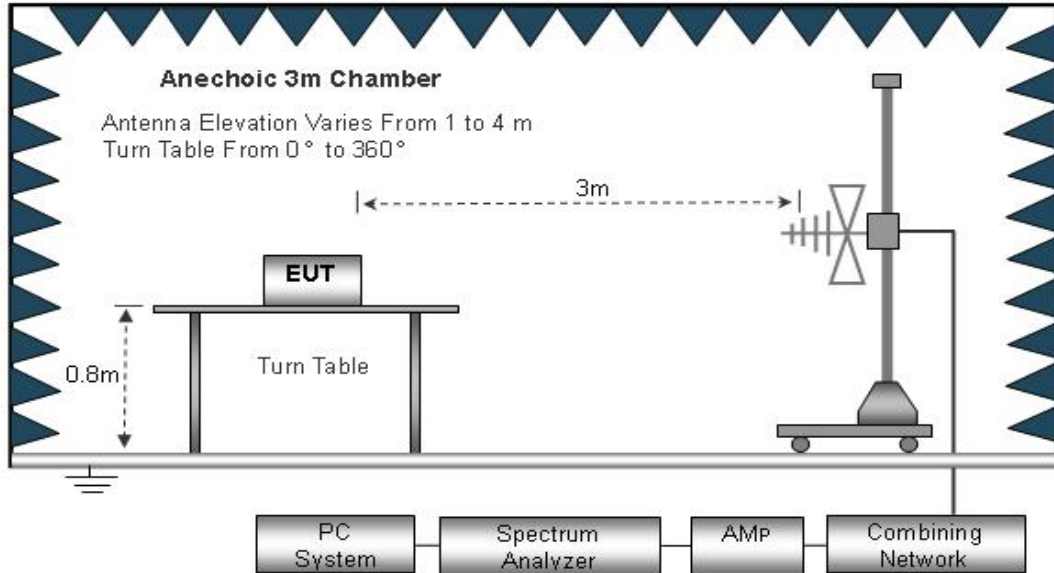

Note: For the actual test configuration, please refer to the related item – Photographs of the Test Configuration

### Test distance define

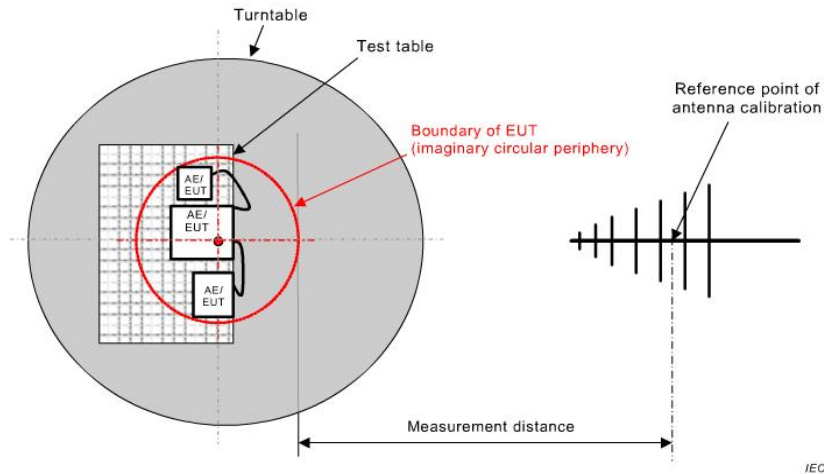

Figure C.1 – Measurement distance

# Test Report

Report No.: RKEYS250731242

Date: Aug.13, 2025

Page 19 of 55

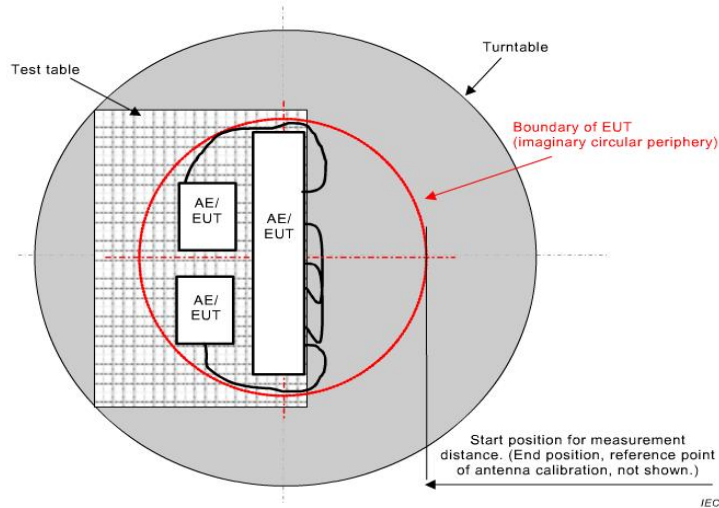

## 7.2.4. TEST RESULT

<b>Product name</b>	Wireless Charger	<b>Tested By</b>	Joy Jiang
<b>Model</b>	MO2651	<b>Detector Function</b>	Quasi-peak
<b>Test Mode</b>	Mode 1	<b>RBW</b>	120kHz
<b>Environmental Conditions</b>	24.3°C, 52% RH, 101.1 kPa	<b>Test Result</b>	Pass

# Test Report

Report No.: RKEYS250731242

Date: Aug.13, 2025

Page 20 of 55

Please refer to the following diagram:

Vertical:

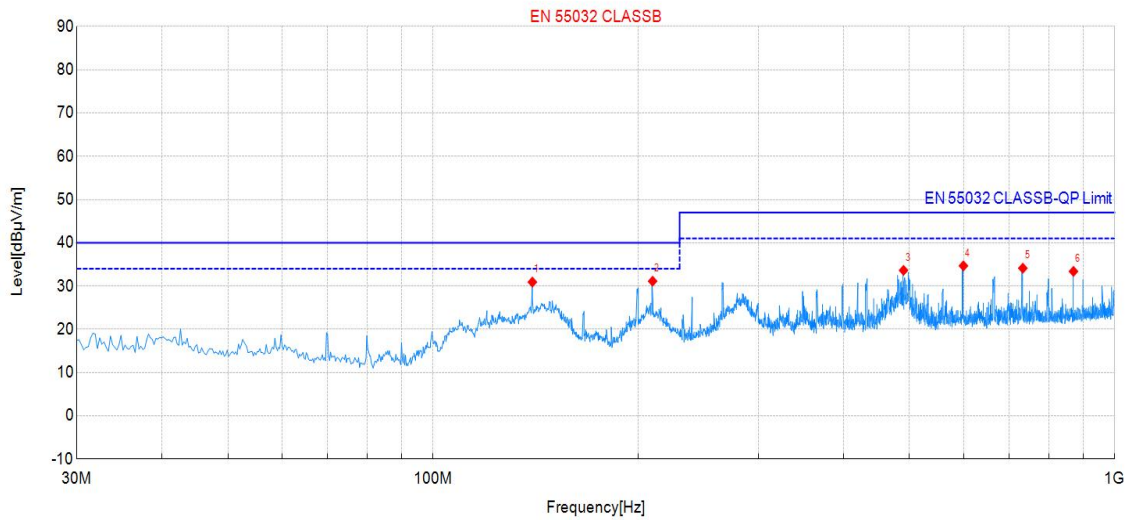

Suspected Data List											
NO.	Frequency [MHz]	Reading [dBµV]	Level [dBµV/m]	Factor [dB/m]	Limit [dBµV/m]	Margin [dB]	Height [cm]	Angle [°]	Det	Pol	Verdict
1	139.85	47.30	30.92	-16.38	40.00	9.08	100	7	QP	Vert	PASS
2	209.94	50.71	31.13	-19.58	40.00	8.87	100	157	QP	Vert	PASS
3	490.02	46.08	33.63	-12.45	47.00	13.37	100	7	QP	Vert	PASS
4	599.88	44.77	34.67	-10.10	47.00	12.33	100	307	QP	Vert	PASS
5	733.25	42.64	34.13	-8.51	47.00	12.87	100	165	QP	Vert	PASS
6	870.02	40.81	33.40	-7.41	47.00	13.60	100	146	QP	Vert	PASS

Note:(1)Level=Reading+Factor

(2)Margin=Limit-Level

# Test Report

Report No.: RKEYS250731242

Date: Aug.13, 2025

Page 21 of 55

Please refer to the following diagram:

Horizontal::

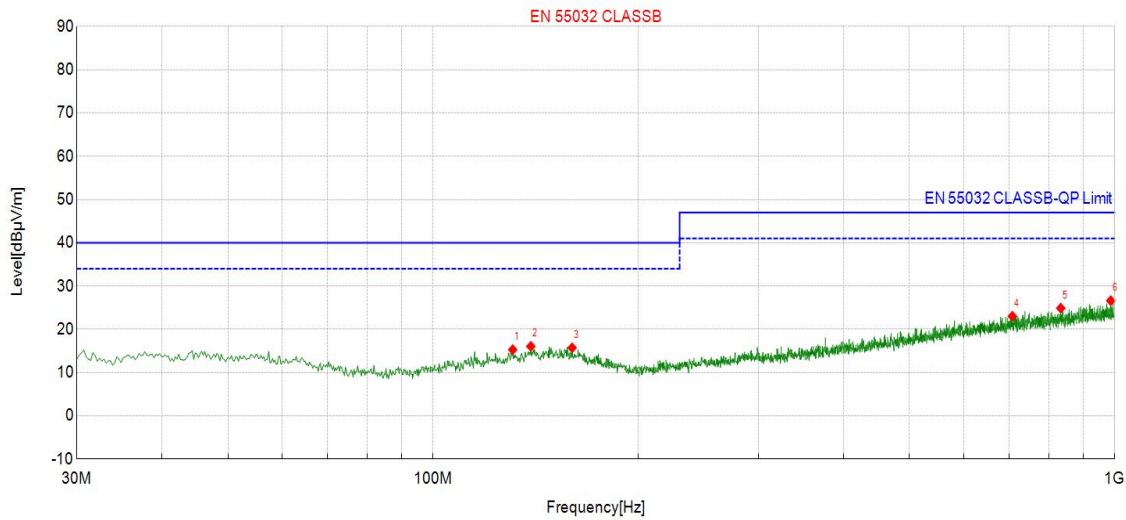

Suspected Data List											
NO.	Frequency [MHz]	Reading [dBµV]	Level [dBµV/m]	Factor [dB/m]	Limit [dBµV/m]	Margin [dB]	Height [cm]	Angle [°]	Det	Pol	Verdict
1	130.88	32.31	15.30	-17.01	40.00	24.70	100	2	QP	Hori	PASS
2	139.13	32.49	16.06	-16.43	40.00	23.94	100	9	QP	Hori	PASS
3	159.98	31.76	15.73	-16.03	40.00	24.27	100	207	QP	Hori	PASS
4	707.79	31.75	23.02	-8.73	47.00	23.98	100	216	QP	Hori	PASS
5	833.40	32.57	24.89	-7.68	47.00	22.11	100	7	QP	Hori	PASS
6	986.91	33.15	26.62	-6.53	47.00	20.38	100	110	QP	Hori	PASS

Note:(1)Level=Reading+Factor

(2)Margin=Limit-Level

# Test Report

## 7.3. RADIATED EMISSION MEASUREMENT(ABOVE 1GHz)

### 7.3.1. LIMITS

FREQUENCY (MHz)	Distance m	Peak dB( $\mu$ V/m)	Average dB( $\mu$ V/m)
1000~3000	3	50	54
3000~ 6000	3	70	74

Note: 1) The lower limit shall apply at the transition frequencies.

2) Emission level (dB $\mu$ V/m) = 20 log Emission level ( $\mu$ V/m).

### 7.3.2. TEST PROCEDURE

- The EUT was placed on the top of an insulating table 0.8 meters above the ground at a semi-anechoic chamber. The table was rotated 360 degrees to determine the position of the highest radiation.
- The EUT was set 3 meters away from the interference-receiving antenna, which was mounted on the top of a variable-height antenna tower.
- The height of antenna is varied from 1 to 4 meter above the ground ,the height of adjustment depends on the EUT height and the antenna 3dB bandwidth both,to determine the maximum value of the field strength. Both horizontal and vertical polarization of the antenna are set to make the measurement.The boresight should be used during the test above 1GHz.
- For each suspected emission, the EUT was arranged to its worst case and then the antenna was tuned to the heights from 1 to 4 meters and the ratable table was turned from 0 degrees to 360 degrees to find the maximum reading.
- The test-receiver system was set to Peak Detector Function and Specified Bandwidth with Maximum Hold Mode when the test frequency is above1GHz.

# Test Report

Report No.: RKEYS250731242

Date: Aug.13, 2025

Page 23 of 55

### 7.3.3. TEST SETUP

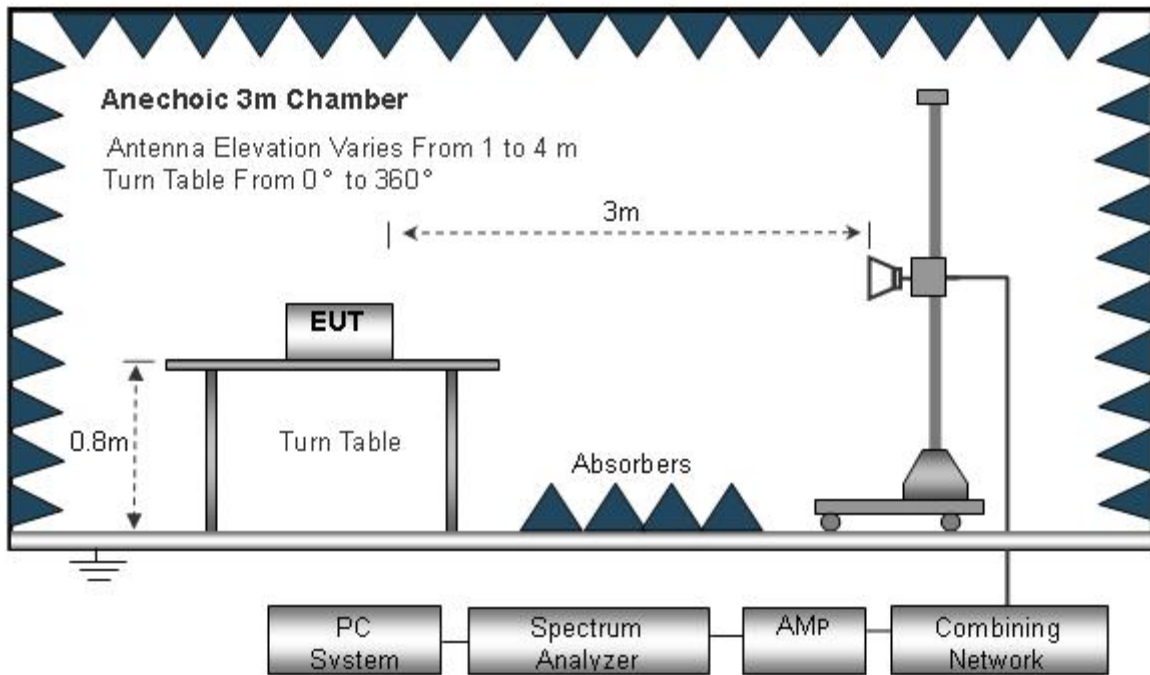

Note: For the actual test configuration, please refer to the related item – Photographs of the Test Configuration

### 7.3.4. TEST RESULT

<b>Product name</b>	Wireless Charger	<b>Tested By</b>	Joy Jiang
<b>Model</b>	MO2651	<b>Detector Function</b>	Peak/AV
<b>Test Mode</b>	Mode 1	<b>RBW</b>	1MHz
<b>Environmental Conditions</b>	24.3°C, 52% RH, 101.1 kPa	<b>Test Result</b>	Pass

# Test Report

Report No.: RKEYS250731242

Date: Aug.13, 2025

Page 24 of 55

Please refer to the following diagram:

Vertical:

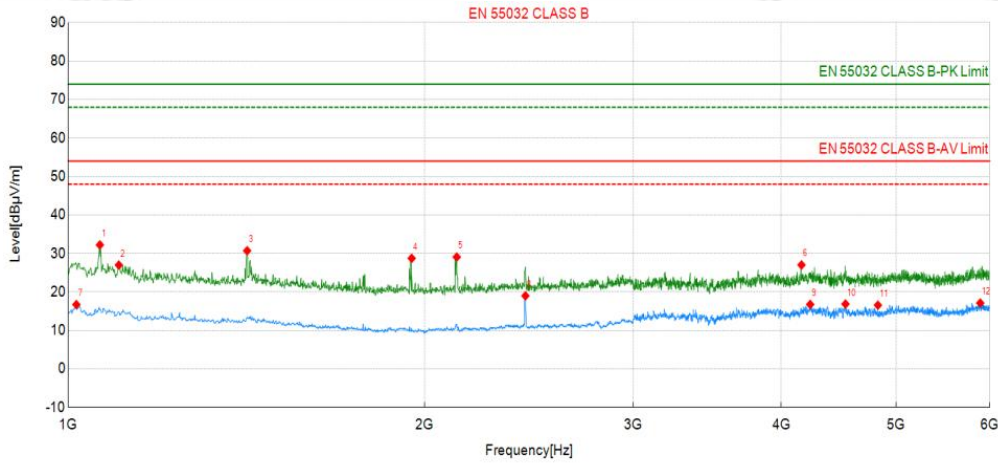

Suspected Data List												
NO.	Frequency [MHz]	Reading [dBuV]	Level [dBuV/m]	Factor [dB/m]	Limit [dBuV/m]	Margin [dB]	Height [cm]	Angle [°]	Det	Pol	Verdict	
1	1063.75	64.69	32.22	-32.47	74.00	41.78	100	90	PK	Hori	PASS	
2	1103.75	59.66	26.98	-32.68	74.00	47.02	100	280	PK	Hori	PASS	
3	1416.25	64.98	30.71	-34.27	74.00	43.29	100	10	PK	Hori	PASS	
4	1950.00	65.74	28.74	-37.00	74.00	45.26	100	250	PK	Hori	PASS	
5	2128.75	66.09	29.07	-37.02	74.00	44.93	100	240	PK	Hori	PASS	
6	4160.00	61.89	27.01	-34.88	74.00	46.99	100	180	PK	Hori	PASS	
7	1016.25	48.95	16.72	-32.23	54.00	37.28	100	340	AV	Hori	PASS	
8	2432.50	55.47	18.99	-36.48	54.00	35.01	100	140	AV	Hori	PASS	
9	4231.25	51.60	16.76	-34.84	54.00	37.24	100	360	AV	Hori	PASS	
10	4531.25	51.53	16.85	-34.68	54.00	37.15	100	230	AV	Hori	PASS	
11	4826.25	51.09	16.56	-34.53	54.00	37.44	100	70	AV	Hori	PASS	
12	5888.75	51.27	17.11	-34.16	54.00	36.89	100	90	AV	Hori	PASS	

Note:(1)Level=Reading+Factor

(2)Margin=Limit-Level

**Guangdong KEYS Testing Technology Co., Ltd.**

Address: Building 1, No.18, Shihuan Road, Dongcheng Subdistrict, Dongguan, Guangdong, China  
 Tel: +86-0769-22221088 <http://www.keys-lab.com> E-mail: [info@keys-lab.com](mailto:info@keys-lab.com)

This report is only responsible for the test results of the samples submitted for inspection, and is not responsible for the source of the samples submitted for inspection.  
 This report shall not be altered, increased or deleted. Without written approval of KEYS, this test report shall not be copied except in full and published as advertisement.



# Test Report

Report No.: RKEYS250731242

Date: Aug.13, 2025

Page 25 of 55

Please refer to the following diagram:

Horizontal:

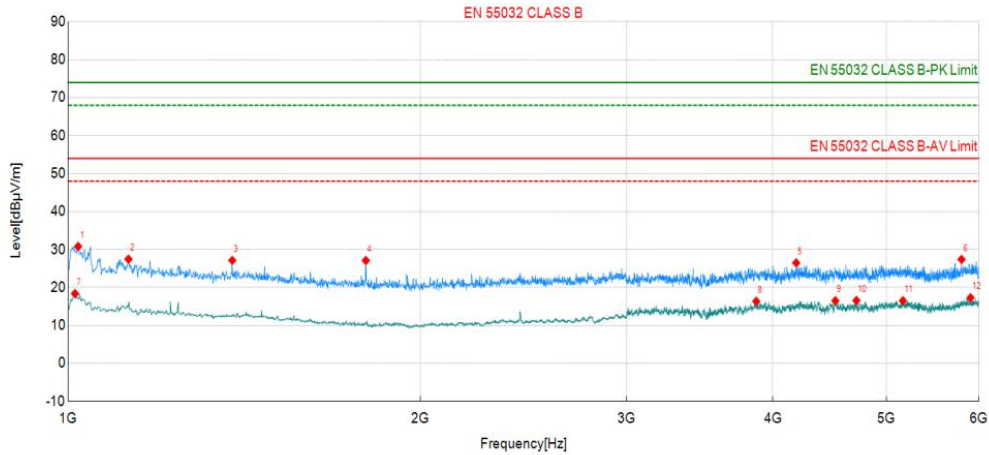

Suspected Data List												
NO.	Frequency [MHz]	Reading [dBµV]	Level [dBµV/m]	Factor [dB/m]	Limit [dBµV/m]	Margin [dB]	Height [cm]	Angle [°]	Det	Pol	Verdict	
1	1020.00	63.06	30.81	-32.25	74.00	43.19	100	120	PK	Vert	PASS	
2	1126.25	60.25	27.46	-32.79	74.00	46.54	100	60	PK	Vert	PASS	
3	1381.25	61.22	27.13	-34.09	74.00	46.87	100	150	PK	Vert	PASS	
4	1796.25	63.31	27.10	-36.21	74.00	46.90	100	120	PK	Vert	PASS	
5	4187.50	61.36	26.49	-34.87	74.00	47.51	100	130	PK	Vert	PASS	
6	5796.25	61.58	27.39	-34.19	74.00	46.61	100	30	PK	Vert	PASS	
7	1013.75	50.62	18.40	-32.22	54.00	35.60	100	280	AV	Vert	PASS	
8	3871.25	51.38	16.35	-35.03	54.00	37.65	100	90	AV	Vert	PASS	
9	4522.50	51.18	16.49	-34.69	54.00	37.51	100	70	AV	Vert	PASS	
10	4713.75	51.13	16.54	-34.59	54.00	37.46	100	100	AV	Vert	PASS	
11	5165.00	50.90	16.51	-34.39	54.00	37.49	100	80	AV	Vert	PASS	
12	5900.00	51.45	17.29	-34.16	54.00	36.71	100	280	AV	Vert	PASS	

Note:(1)Level=Reading+Factor

(2)Margin=Limit-Level

# Test Report

Report No.: RKEYS250731242

Date: Aug.13, 2025

Page 26 of 55

## 7.4. HARMONICS CURRENT MEASUREMENT

### 7.4.1. LIMITS OF HARMONICS CURRENT MEASUREMENT

Limit for Class A equipment		Limit for Class D equipment		
Harmonics Order N	Max. permissible harmonics current A	Harmonics Order n	Max. permissible harmonics current per watt mA/W	Max. permissible harmonics current A
Odd harmonics		Odd Harmonics only		
3	2.30	3	3.4	2.30
5	1.14	5	1.9	1.14
7	0.77	7	1.0	0.77
9	0.40	9	0.5	0.40
11	0.33	11	0.35	0.33
13	0.21	13	0.30	0.21
$15 \leq n \leq 39$	$0.15 \times (15/n)$	$15 \leq n \leq 39$ (odd harmonics only)	$3.85/n$	$0.15 \times (15/n)$
Even harmonics				
2	1.08			
4	0.43			
6	0.30			
$8 \leq n \leq 40$	$0.23 \times 8/n$			

Limit for Class C equipment	
Harmonics Order n	Max. permissible harmonics current expressed as a percentage of the input current at the fundamental frequency A
2	2
3	30xF
5	10
7	7
9	5
$11 \leq n < \leq 39$ (odd harmonics only)	3

F is the circuit power factor

# Test Report

Report No.: RKEYS250731242

Date: Aug.13, 2025

Page 27 of 55

Note: Class A, B, C and D are classified according to item 7.4.2.of this report

## 7.4.2. TEST PROCEDURE

The EUT was placed on the top of a wooden table 0.8 meters above the ground and operated to produce the maximum harmonic. The classification of EUT is according to section 5 of EN 61000-3-2.

The EUT is classified as follows:

Class A:

Balanced three-phase equipment, Household appliances excluding equipment as Class D, Tools excluding portable tools, Dimmers for incandescent lamps, audio equipment, equipment not specified in one of the three other classes.

Class B:

Portable tools; Arc welding equipment which is not professional equipment.

Class C:

Lighting equipment

Class D:

Equipment having a specified power less than or equal to 600 W of the following types: Personal computers and personal computer monitors and television receivers.

The correspondent test program of test instrument to measure the current harmonics emanated from EUT is chosen.

The measure time shall be not less than the time necessary for the EUT to be exercised.

## 7.4.3. TEST SETUP

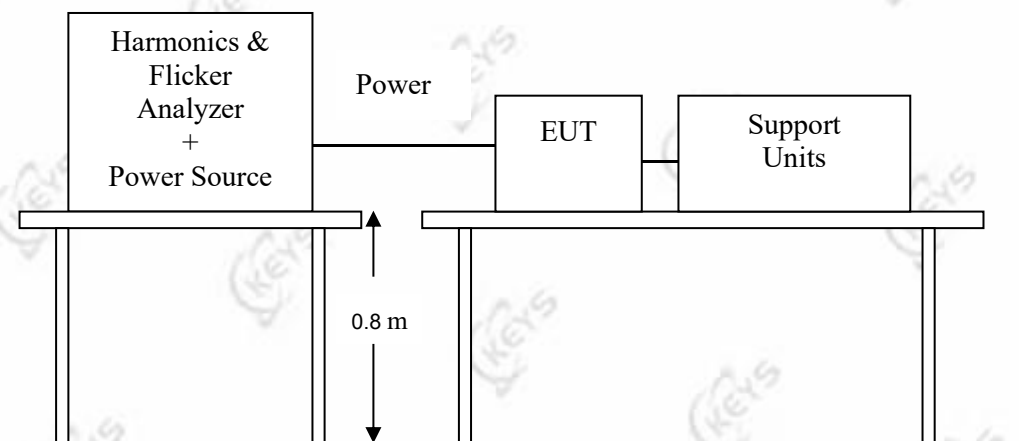

For the actual test configuration, please refer to the related item – Photographs of the Test Configuration.

## 7.4.4. TEST RESULT

N/A

**Guangdong KEYS Testing Technology Co., Ltd.**

Address: Building 1, No.18, Shihuan Road, Dongcheng Subdistrict, Dongguan, Guangdong, China  
Tel: +86-0769-22221088 <http://www.keys-lab.com> E-mail: [info@keys-lab.com](mailto:info@keys-lab.com)

This report is only responsible for the test results of the samples submitted for inspection, and is not responsible for the source of the samples submitted for inspection. This report shall not be altered, increased or deleted. Without written approval of KEYS, this test report shall not be copied except in full and published as advertisement.

# Test Report

Report No.: RKEYS250731242

Date: Aug.13, 2025

Page 28 of 55

## 7.5. VOLTAGE FLUCTUATION AND FLICKS MEASUREMENT

### 7.5.1. LIMITS OF VOLTAGE FLUCTUATION AND FLICKS MEASUREMENT

TEST ITEM	LIMIT	REMARK
$P_{st}$	1.0	$P_{st}$ means short-term flicker indicator.
$P_{lt}$	0.65	$P_{lt}$ means long-term flicker indicator.
$T_{dt}$ (ms)	500	$T_{dt}$ means maximum time that dt exceeds 3 %.
$d_{max}$ (%)	4/6/7 %	$d_{max}$ means maximum relative voltage change.
dc (%)	3.3 %	dc means relative steady-state voltage change

### 7.5.2. TEST PROCEDURE

The EUT was placed on the top of a wooden table 0.8 meters above the ground and operated to produce the most unfavorable sequence of voltage changes under lighting operating conditions.

During the flick measurement, the measure time shall include that part of whole operation cycle in which the EUT produce the most unfavorable sequence of voltage changes. The observation period for short-term flicker indicator is 10 minutes and the observation period for long-term flicker indicator is 2 hours.

### 7.5.3. TEST SETUP

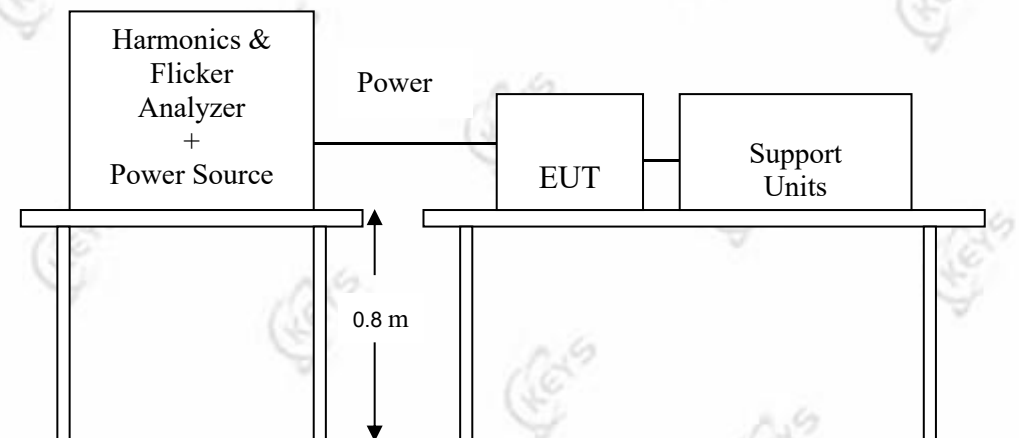

For the actual test configuration, please refer to the related item – Photographs of the Test Configuration.

# Test Report

Report No.: RKEYS250731242

Date: Aug.13, 2025

Page 29 of 55

## 7.5.4. TEST RESULT

N/A

# Test Report

Report No.: RKEYS250731242

Date: Aug.13, 2025

Page 30 of 55

## 8. IMMUNITY TEST

### PERFORMANCE CRITERIA DESCRIPTION

#### EN 301 489-1 V2.2.3 Clause 6 requirements:

##### Performance criteria for continuous phenomena

During the test, the equipment shall:

- continue to operate as intended;
- not unintentionally transmit;
- not unintentionally change its operating state;
- not unintentionally change critical stored data

##### Performance criteria for transient phenomena

For all ports and transient phenomena with the exception described below, the following applies:

- The application of the transient phenomena shall not result in a change of the mode of operation (e.g. unintended transmission) or the loss of critical stored data.
- After application of the transient phenomena, the equipment shall operate as intended.

For surges applied to symmetrically operated wired network ports intended to be connected directly to outdoor lines the following criteria applies:

- For products with only one symmetrical port intended for connection to outdoor lines, loss of function is allowed, provided the function is self-recoverable, or can be otherwise restored. Information stored in non-volatile memory, or protected by a battery backup, shall not be lost.
- For products with more than one symmetrical port intended for connection to outdoor lines, loss of function on the port under test is allowed, provided the function is self-recoverable. Information stored in non-volatile memory, or protected by a battery backup, shall not be lost.

#### EN 301 489-3 V3.3.1 Clause 6 requirements:

##### 6 General performance criteria

##### 6.1 The performance criteria are:

- performance criteria A for immunity tests with phenomena of a continuous nature;
- performance criteria B for immunity tests with phenomena of a transient nature;
- performance criteria C for immunity tests with power interruptions exceeding a certain time.

The equipment shall meet the minimum performance criteria as specified in the following clauses.

##### 6.2 Performance table

##### 6.2.1 Performance criteria overview

# Test Report

Report No.: RKEYS250731242

Date: Aug.13, 2025

Page 31 of 55

Criteria	During test	After test (i.e. as a result of the application of the test)
A	Shall operate as intended. (See note). Shall be no loss of function. Shall be no unintentional transmissions.	Shall operate as intended. Shall be no degradation of performance. Shall be no loss of function. Shall be no loss of critical stored data.
B	May be loss of function.	Functions shall be self-recoverable. Shall operate as intended after recovering. Shall be no loss of critical stored data.
C	May be loss of function.	Functions shall be recoverable by the operator. Shall operate as intended after recovering. Shall be no loss of critical stored data

NOTE: Operate as intended during the test allows a level of degradation in accordance with clause 6.2.2.

## 6.2.2 Minimum performance level

For equipment that supports a PER or FER, the minimum performance level shall be a PER or FER less than or equal to 10 %.

For equipment that does not support a PER or a FER, the minimum performance level shall be no loss of the wireless transmission function needed for the intended use of the equipment.

## 6.3 Performance criteria for Continuous phenomena

The performance criteria A shall apply.

Where the EUT is a transmitter in standby mode, unintentional transmission shall not occur during the test.

Where the EUT is a transceiver in receive mode, unintentional transmission shall not occur during the test.

## 6.4 Performance criteria for Transient phenomena

The performance criteria B shall apply, except for voltage dips greater than or equal to 100 ms and voltage interruptions of 5 000 ms duration, for which performance criteria C shall apply.

Where the EUT is a transmitter in standby mode, unintentional transmission shall not occur as a result of the application of the test.

Where the EUT is a transceiver in receive mode, unintentional transmission shall not occur as a result of the application of the test.

# Test Report

Report No.: RKEYS250731242

Date: Aug.13, 2025

Page 32 of 55

## 8.1. ELECTROSTATIC DISCHARGE (ESD)

### 8.1.1. TEST SPECIFICATION

<b>Test Standard:</b>	EN 301 489-1 EN 301 489-3
<b>Basic Standard:</b>	EN 61000-4-2
<b>Discharge Impedance:</b>	330 Ω
<b>Charging Capacity:</b>	150 pF
<b>Discharge Voltage:</b>	Air Discharge: ±8 kV (Direct) Contact Discharge: ± 4 kV (Direct/Indirect)
<b>Polarity:</b>	Positive & Negative
<b>Number of Discharge:</b>	10 (Air discharge for single polarity discharge) 25 (Contact discharge for single polarity discharge)
<b>Discharge Mode:</b>	1 time/s
<b>Performance Criterion:</b>	B

### 8.1.2. TEST PROCEDURE

The discharges shall be applied in two ways:

- Contact discharges to the conductive surfaces and coupling planes:  
50 dischargers (25 with positive and 25 with negative polarity) shall be applied on each accessible metallic part of the enclosure, terminals are excluded. In case of a non-conductive enclosure, dischargers shall be applied on the horizontal or vertical coupling planes. Test shall be performed at a maximum repetition rate of one discharge per second.
- Air discharges at slots and apertures and insulating surfaces:  
On those parts of the EUT where it is not possible to perform contact discharge testing, the equipment should be investigated to identify user accessible points where breakdown may occur. Such points are tested using the air discharge method. This investigation should be restricted to those area normally handled by the user. A minimum of 10 single air discharges shall be applied to the selected test point for each such area.

The basic test procedure was in accordance with EN 61000-4-2:

- The EUT was located 0.1 m minimum from all side of the HCP (dimensions 1.6 m x 0.8 m).
- The support units were located another table 30 cm away from the EUT, but direct support unit was/were located at same location as EUT on the HCP and keep at a distance of 10cm with EUT.
- The time interval between two successive single discharges was at least 1 second.
- Contact discharges were applied to the non-insulating coating, with the pointed tip of the generator penetrating

**Guangdong KEYS Testing Technology Co., Ltd.**

Address: Building 1, No.18, Shihuan Road, Dongcheng Subdistrict, Dongguan, Guangdong, China  
Tel: +86-0769-22221088 <http://www.keys-lab.com> E-mail: [info@keys-lab.com](mailto:info@keys-lab.com)

This report is only responsible for the test results of the samples submitted for inspection, and is not responsible for the source of the samples submitted for inspection. This report shall not be altered, increased or deleted. Without written approval of KEYS, this test report shall not be copied except in full and published as advertisement.



# Test Report

Report No.: RKEYS250731242

Date: Aug.13, 2025

Page 33 of 55

the coating and contacting the conducting substrate.

- e) Air discharges were applied with the round discharge tip of the discharge electrode approaching the EUT as fast as possible (without causing mechanical damage) to touch the EUT. After each discharge, the ESD generator was removed from the EUT and re-triggered for a new single discharge. The test was repeated until all discharges were complete.
- f) At least ten single discharges (in the most sensitive polarity) were applied at the front edge of each HCP opposite the center point of each unit of the EUT and 0.1 meter from the front of the EUT. The long axis of the discharge electrode was in the plane of the HCP and perpendicular to its front edge during the discharge.
- g) At least ten single discharges (in the most sensitive polarity) were applied to the center of one vertical edge of the Vertical Coupling Plane (VCP) in sufficiently different positions that the four faces of the EUT were completely illuminated. The VCP (dimensions 0.5 m x 0.5 m) was placed vertically to and 0.1 meter from the EUT.

# Test Report

Report No.: RKEYS250731242

Date: Aug.13, 2025

Page 34 of 55

## 8.1.3. TEST SETUP

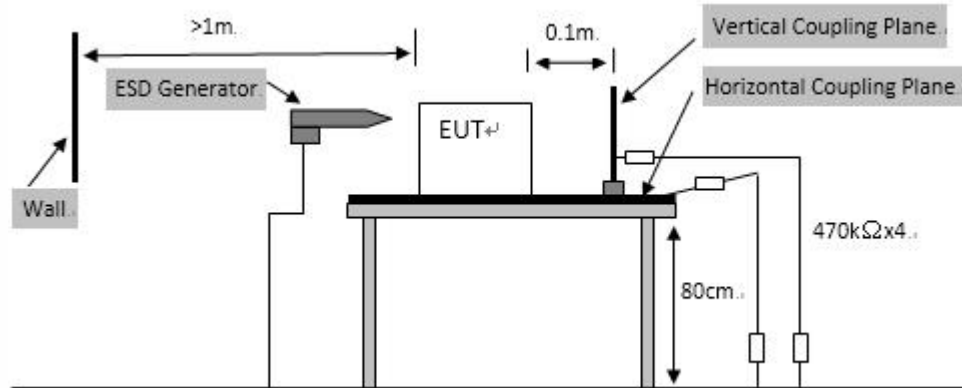

For the actual test configuration, please refer to the related item – Photographs of the Test Configuration.

Note:

### 1) TABLE-TOP EQUIPMENT

The configuration consisted of a wooden table 0.8 meters high standing on the ground reference plane (GRP). The GRP consisted of a sheet of aluminum at least 0.25 mm thick, and 2.5 meters square connected to the protective grounding system. A horizontal coupling plane (HCP) (1.6 m x 0.8 m) was placed on the table and attached to the GRP by means of a cable with 940k total impedance. The equipment under test, was installed in a representative system as described in section 7 of EN 61000-4-2, and its cables were placed on the HCP and isolated by an insulating support of 0.5 mm thickness. A distance of 1-meter minimum was provided between the EUT and the walls of the laboratory and any other metallic structure.

### 2) FLOOR-STANDING EQUIPMENT

The equipment under test was installed in a representative system as described in section 7 of IEC 61000-4-2, and its cables were isolated from the ground reference plane by an insulating support of 0.1 meter thickness. The GRP consisted of a sheet of aluminum that is at least 0.25 mm thick, and 2.5 meters square connected to the protective grounding system and extended at least 0.5 meters from the EUT on all sides.

# Test Report

Report No.: RKEYS250731242

Date: Aug.13, 2025

Page 35 of 55

## 8.1.4. TEST RESULT

<b>Product</b>	Wireless Charger	<b>Environmental Conditions</b>	24.1°C, 55% RH, 101.14 kPa
<b>Model</b>	MO2651	<b>Tested By</b>	Joy Jiang
<b>Test mode</b>	All mode	<b>Test Result</b>	Pass

Discharge Type	Level (kV)	Test Point	Observation	Performance Criterion
Contact Discharge	± 4	2	Note <input type="checkbox"/> 1 <input checked="" type="checkbox"/> 2 <input type="checkbox"/> 3	B
Direct Air Discharge	± 8	1	Note <input type="checkbox"/> 1 <input checked="" type="checkbox"/> 2 <input type="checkbox"/> 3	B
Indirect Discharge (HCP)	± 4	3	Note <input type="checkbox"/> 1 <input checked="" type="checkbox"/> 2 <input type="checkbox"/> 3	B
Indirect Discharge (VCP)	± 4	3	Note <input type="checkbox"/> 1 <input checked="" type="checkbox"/> 2 <input type="checkbox"/> 3	B

Test point:

- All insulated enclosure and seams.
- All accessible metal parts of the enclosure
- All side

Note:

- No degradation in performance of the EUT was observed.
- During the test, Loss of functionality, after the experiment, the function can automatically return to normal.
- Loss of functionality, but self-recoverable by user, without loss of information or settings.

# Test Report

Report No.: RKEYS250731242

Date: Aug.13, 2025

Page 36 of 55

## 8.2. RADIATED, RADIO-FREQUENCY, ELECTROMAGNETIC FIELD (RS)

### 8.2.1. TEST SPECIFICATION

<b>Test Standard:</b>	EN 301 489-1 EN 301 489-3
<b>Basic Standard:</b>	EN IEC 61000-4-3
<b>Frequency Range:</b>	EN 301 489-1/-3: 80 ~6GHz
<b>Field Strength:</b>	3 V/m
<b>Modulation:</b>	1 kHz Sine Wave, 80 %, AM Modulation
<b>Frequency Step:</b>	1 % of preceding frequency value
<b>Polarity of Antenna:</b>	Horizontal and Vertical
<b>Test Distance:</b>	3 m
<b>Antenna Height:</b>	1.5 m
<b>Performance Criterion:</b>	A

### 8.2.2. TEST PROCEDURE

The test procedure was in accordance with EN IEC 61000-4-3

- The testing was performed in a fully anechoic chamber. The transmit antenna was located at a distance of 3 meters from the EUT.
- The frequency range is swept from 80 MHz to 1000 MHz, with the signal 80% amplitude modulated with a 1 kHz sine-wave. The rate of sweep did not exceed  $1.5 \times 10^{-3}$  decade/s, where the frequency range is swept incrementally, the step size was 1 % of preceding frequency value.
- The dwell time at each frequency shall be not less than the time necessary for the EUT to be able to respond.
- The test was performed with the EUT exposed to both vertically and horizontally polarized fields on each of the four sides.

# Test Report

Report No.: RKEYS250731242

Date: Aug.13, 2025

Page 37 of 55

## 8.2.3. TEST SETUP

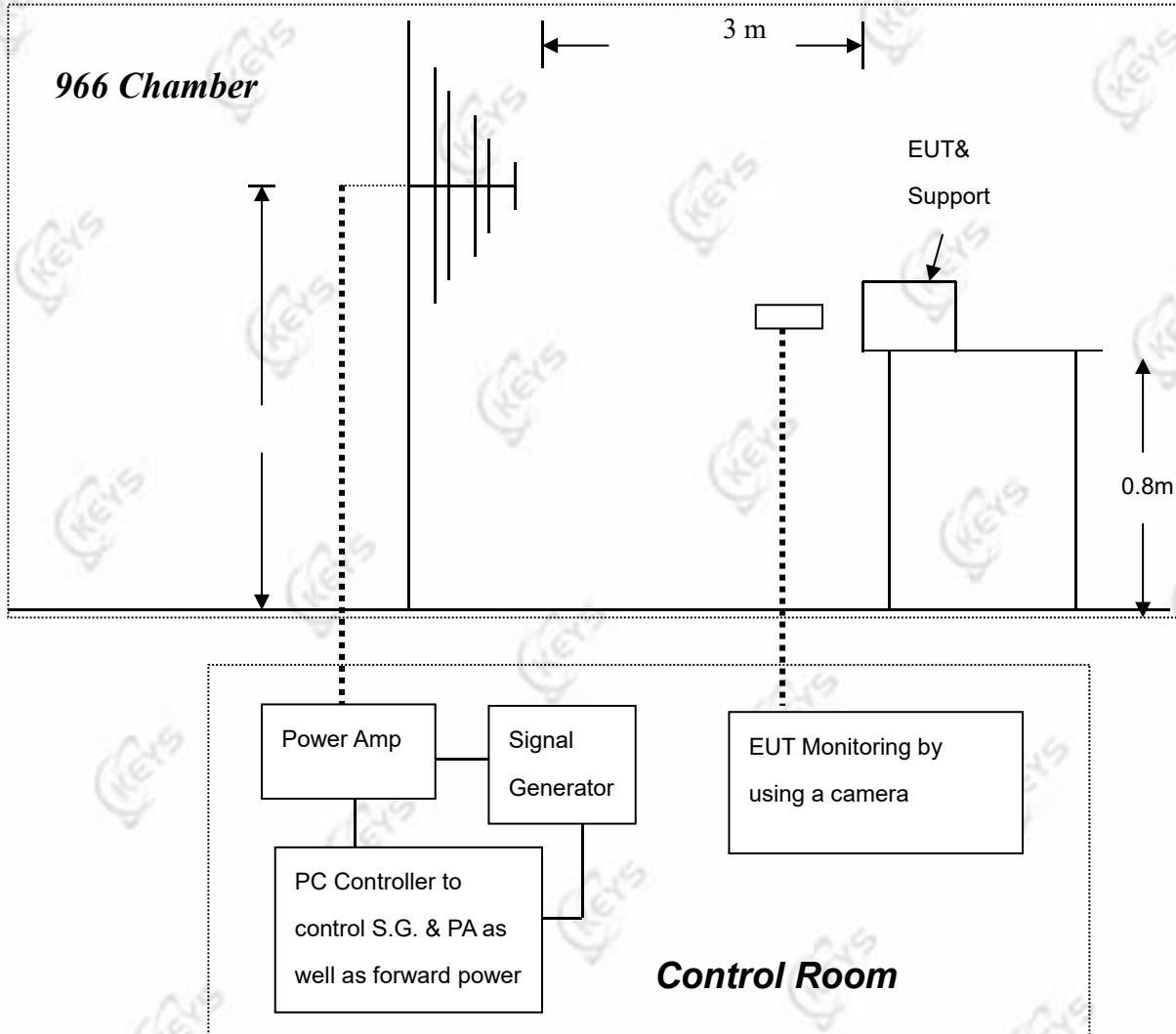

For the actual test configuration, please refer to the related item – Photographs of the Test Configuration.

Note:

### TABLETOP EQUIPMENT

The EUT installed in a representative system as described in section 7 of EN 61000-4-3 was placed on a non-conductive table 0.8 meters in height. The system under test was connected to the power and signal wire according to relevant installation instructions.

### FLOOR STANDING EQUIPMENT

The EUT installed in a representative system as described in section 7 of IEC 61000-4-3 was placed on a non-conductive wood support 0.1 meters in height. The system under test was connected to the power and signal wire according to relevant installation instructions.

**Guangdong KEYS Testing Technology Co., Ltd.**

Address: Building 1, No.18, Shihuan Road, Dongcheng Subdistrict, Dongguan, Guangdong, China  
 Tel: +86-0769-22221088 <http://www.keys-lab.com> E-mail: [info@keys-lab.com](mailto:info@keys-lab.com)

This report is only responsible for the test results of the samples submitted for inspection, and is not responsible for the source of the samples submitted for inspection. This report shall not be altered, increased or deleted. Without written approval of KEYS, this test report shall not be copied except in full and published as advertisement.

# Test Report

Report No.: RKEYS250731242

Date: Aug.13, 2025

Page 38 of 55

## 8.2.4. TEST RESULT

<b>Product</b>	Wireless Charger	<b>Environmental Conditions</b>	24.1°C, 51% RH, 101.12 kPa
<b>Model</b>	MO2651	<b>Tested By</b>	Joy Jiang
<b>Test mode</b>	All mode	<b>Test Result</b>	Pass

For EN 301 489-1/-17

Frequency (MHz)	Polarity	Position	Field Strength (V/m)	Observation	Performance Criterion
80 ~6GHz	V&H	Front	3	Note <input checked="" type="checkbox"/> 1 <input type="checkbox"/> 2 <input type="checkbox"/> 3	A
	V&H	Rear	3	Note <input checked="" type="checkbox"/> 1 <input type="checkbox"/> 2 <input type="checkbox"/> 3	A
	V&H	Left	3	Note <input checked="" type="checkbox"/> 1 <input type="checkbox"/> 2 <input type="checkbox"/> 3	A
	V&H	Right	3	Note <input checked="" type="checkbox"/> 1 <input type="checkbox"/> 2 <input type="checkbox"/> 3	A

Note:

- 1) No degradation in performance of the EUT was observed.
- 2) During the test, Loss of functionality, after the experiment, the function can automatically return to normal.
- 3) Loss of functionality, but self-recoverable by user, without loss of information or settings.

# Test Report

Report No.: RKEYS250731242

Date: Aug.13, 2025

Page 39 of 55

## 8.3. ELECTRICAL FAST TRANSIENT (EFT)

### 8.3.1. TEST SPECIFICATION

<b>Test Standard:</b>	EN 301 489-1/-3
<b>Basic Standard:</b>	EN 61000-4-4
<b>Test Voltage:</b>	Power Line: $\pm 1$ kV Signal/Control Line: $\pm 0.5$ kV
<b>Polarity:</b>	Positive & Negative
<b>Impulse Frequency:</b>	5 kHz
<b>Impulse Wave-shape:</b>	5/50 ns
<b>Burst Duration:</b>	15 ms
<b>Burst Period:</b>	300 ms
<b>Test Duration:</b>	2 mins
<b>Performance Criterion:</b>	B

### 8.3.2. TEST PROCEDURE

EUT is placed on a 0.1 m tall wooden table.

EUT operate at normal mode, the transient/burst was 5/50 ns in accordance with BS EN 61000-4-4, both positive and negative polarity burst waveform were applied.

The duration time of each test line was 2 minutes.

### 8.3.3. TEST SETUP

The EUT installed in a representative system as described in section 7 of EN 61000-4-4.

For the actual test configuration, please refer to the related item – photographs of the test configuration.

# Test Report

Report No.: RKEYS250731242

Date: Aug.13, 2025

Page 40 of 55

## 8.3.4. TEST RESULT

N/A



# Test Report

Report No.: RKEYS250731242

Date: Aug.13, 2025

Page 41 of 55

## 8.4. SURGE IMMUNITY TEST

### 8.4.1. TEST SPECIFICATION

<b>Test Standard:</b>	EN 301 489-1/-3
<b>Basic Standard:</b>	EN 61000-4-5
<b>Wave-Shape:</b>	Combination Wave 1.2/50 $\mu$ s Open Circuit Voltage 8/20 $\mu$ s Short Circuit Current
<b>Test Voltage:</b>	Power Port ~ Line to line: $\pm 1$ kV, Line to ground: $\pm 2$ kV
<b>Surge Input/Output:</b>	Power Line: L-N / L-PE / N-PE
<b>Generator Source Impedance:</b>	2 $\Omega$ between networks 12 $\Omega$ between network and ground
<b>Polarity:</b>	Positive/Negative
<b>Phase Angle:</b>	0°/90°/180°/270°
<b>Pulse Repetition Rate:</b>	1 time / min
<b>Number of Tests:</b>	5 positive polarity pulses, and 5 negative polarity pulses
<b>Performance Criterion:</b>	B

### 8.4.2. TEST PROCEDURE

EUT is placed on a 0.8 m tall wooden table.

EUT operate at normal mode, two types of combination wave generator (1.2/50 us open-circuit voltage and 8/20 us short-circuit current) are applied to the EUT power supply terminals via the capacitive coupling network.

The power cord between the EUT and the coupling/decoupling network shall not exceed 2 m in length.

# Test Report

Report No.: RKEYS250731242

Date: Aug.13, 2025

Page 42 of 55

## 8.4.3. TEST SETUP

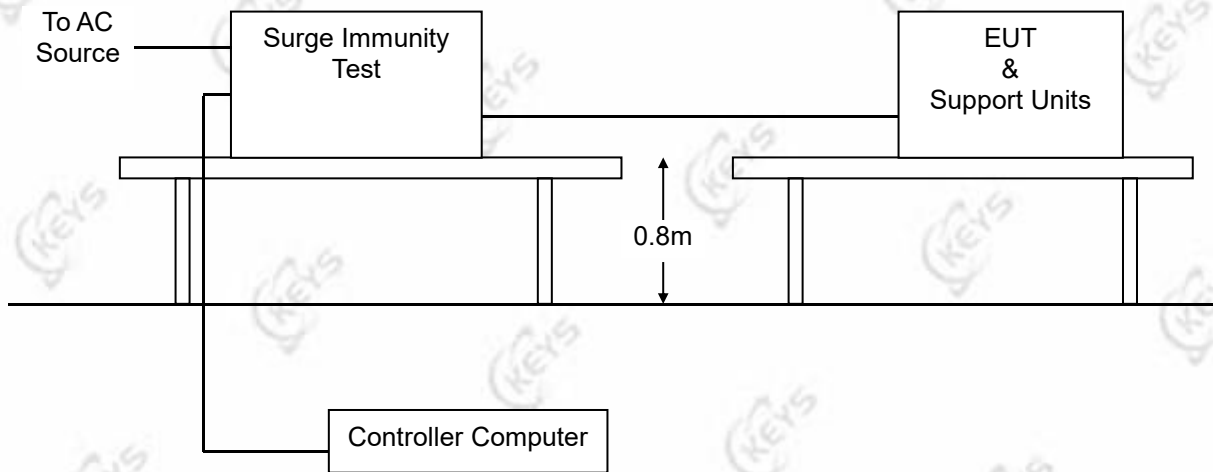

For the actual test configuration, please refer to the related item – Photographs of the Test Configuration.

## 8.4.4. TEST RESULT

N/A

# Test Report

Report No.: RKEYS250731242

Date: Aug.13, 2025

Page 43 of 55

## 8.5. CONDUCTED RADIO FREQUENCY DISTURBANCES (CS)

### 8.5.1. TEST SPECIFICATION

<b>Test Standard:</b>	EN 301 489-1/-3
<b>Basic Standard:</b>	EN IEC 61000-4-6
<b>Frequency Range:</b>	0.15MHz-10MHz: 3V, 10MHz-30MHz: 3V to 1V 30MHz-80MHz: 1V
<b>Field Strength:</b>	3 V
<b>Modulation:</b>	1 kHz Sine Wave, 80 %, AM Modulation
<b>Frequency Step:</b>	1 % of preceding frequency value
<b>Coupled cable:</b>	Power Mains, Shielded
<b>Coupling device:</b>	CDN-M3/2 (3 wires/2 wires)
<b>Performance Criterion:</b>	A

### 8.5.2. TEST PROCEDURE

The EUT shall be tested within its intended operating and climatic conditions. The test shall be performed with the test generator connected to each of the coupling and decoupling devices in turn, while the other non-excited RF input ports of the coupling devices are terminated by a 50 Ω load resistor. The frequency range was swept from 150 kHz to 80 MHz, using the signal level established during the setting process and with a disturbance signal of 80 % amplitude. The signal was modulated with a 1 kHz sine wave, pausing to adjust the RF signal level or the switch coupling devices as necessary. The sweep rate was  $1.5 \times 10^{-3}$  decades/s. Where the frequency range is swept incrementally, the step size was 1 % of preceding frequency value the dwell time of the amplitude modulated carrier at each frequency was 0.5 s.

### 8.5.3. TEST SETUP

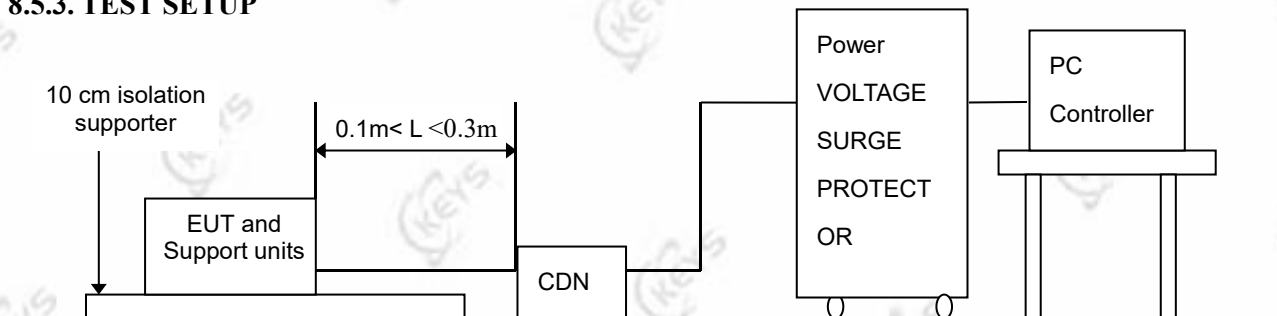

For the actual test configuration, please refer to the related item – Photographs of the Test Configuration

Note: 1) The EUT is setup 0.1 m above Ground Reference Plane

- 2) All relevant cables shall be provided with the appropriate coupling and decoupling devices at a distance between 0.1 meters and 0.3 meters from the projected geometry of the EUT on the ground reference plane.

# Test Report

Report No.: RKEYS250731242

Date: Aug.13, 2025

Page 44 of 55

## 8.5.4. TEST RESULT

N/A

# Test Report

Report No.: RKEYS250731242

Date: Aug.13, 2025

Page 45 of 55

## 8.6. POWER FREQUENCY MAGNETIC FIELD

### 8.6.1. TEST SPECIFICATION

<b>Test Standard:</b>	EN 301 489-1/-3
<b>Basic Standard:</b>	EN 61000-4-8
<b>Frequency Range:</b>	50 Hz
<b>Field Strength:</b>	1 A/m
<b>Observation Time:</b>	5 minutes
<b>Inductance Coil:</b>	Rectangular type, 1 m x 1 m
<b>Performance Criterion:</b>	A

### 8.6.2. TEST PROCEDURE

The equipment is configured and connected to satisfy its functional requirements. It shall be placed on the GRP with the interposition of a 0.1 m-thick insulating support.

The equipment cabinets shall be connected to the safety earth directly on the GRP via the earth terminal of the EUT.

The power supply, input and output circuits shall be connected to the sources of power supply, control and signal.

The cables supplied or recommended by the equipment manufacturer shall be used. 1 meter of all cables used shall be exposed to the magnetic field.

# Test Report

Report No.: RKEYS250731242

Date: Aug.13, 2025

Page 46 of 55

## 8.6.3. TEST SETUP

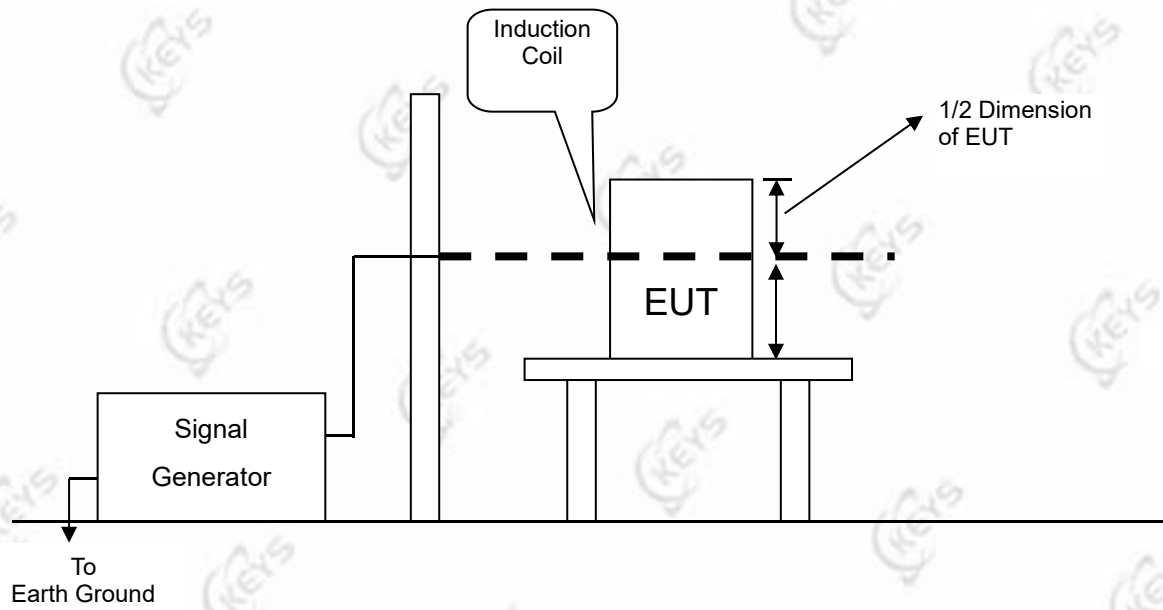

For the actual test configuration, please refer to the related item – Photographs of the Test Configuration  
Note:

### TABLETOP EQUIPMENT

The equipment shall be subjected to the test magnetic field by using the induction coil of standard dimension (1 m x 1 m). The induction coil shall then be rotated by 90 degrees in order to expose the EUT to the test field with different orientations.

### FLOOR-STANDING EQUIPMENT

The equipment shall be subjected to the test magnetic field by using induction coils of suitable dimensions. The test shall be repeated by moving and shifting the induction coils, in order to test the whole volume of the EUT for each orthogonal direction. The test shall be repeated with the coil shifted to different positions along the side of the EUT, in steps corresponding to 50 % of the shortest side of the coil. The induction coil shall then be rotated by 90 degrees in order to expose the EUT to the test field with different orientations.

# Test Report

Report No.: RKEYS250731242

Date: Aug.13, 2025

Page 47 of 55

## 8.6.4. TEST RESULT

N/A.

# Test Report

Report No.: RKEYS250731242

Date: Aug.13, 2025

Page 48 of 55

## 8.7. VOLTAGE DIP & VOLTAGE INTERRUPTIONS

### 8.7.1. TEST SPECIFICATION

<b>Test Standard:</b>	EN 301 489-1/-3	
<b>Basic Standard:</b>	EN IEC 61000-4-11	
<b>Test Duration Time:</b>	3 test events in sequence	
<b>Interval Between Event:</b>	10 seconds	
<b>Phase Angle:</b>	0°	
<b>Test Cycle:</b>	3 times	
<b>Performance Criterion:</b>	EN 301 489-1/-3	EN 55035
	voltage dip:	voltage dip:
	0 % residual voltage for 0,5 cycle;	<5% residual voltage for 0,5
	voltage dip: B	cycle;B
	0 % residual voltage for 1 cycle;	voltage dip:
	voltage dip: B	70 % residual voltage for 25
	70 % residual voltage for 25 cycles	cycles (at 50 Hz);C
	(at 50 Hz);B	Voltage interruption:
	Voltage interruption:	<5% residual voltage for 250
	0 % residual voltage for 250 cycles	cycles (at 50 Hz).C
	(at 50 Hz): C	

### 8.7.2. TEST PROCEDURE

The EUT and support units were located on a wooden table, 0.8 m away from ground floor.

Setting the parameter of tests and then perform the test software of test simulator.

Changes to the voltage level shall occur at 0 degree crossing point in the a.c. voltage waveform.

Record the test result in test record form.



# Test Report

Report No.: RKEYS250731242

Date: Aug.13, 2025

Page 49 of 55

## 8.7.3. TEST SETUP

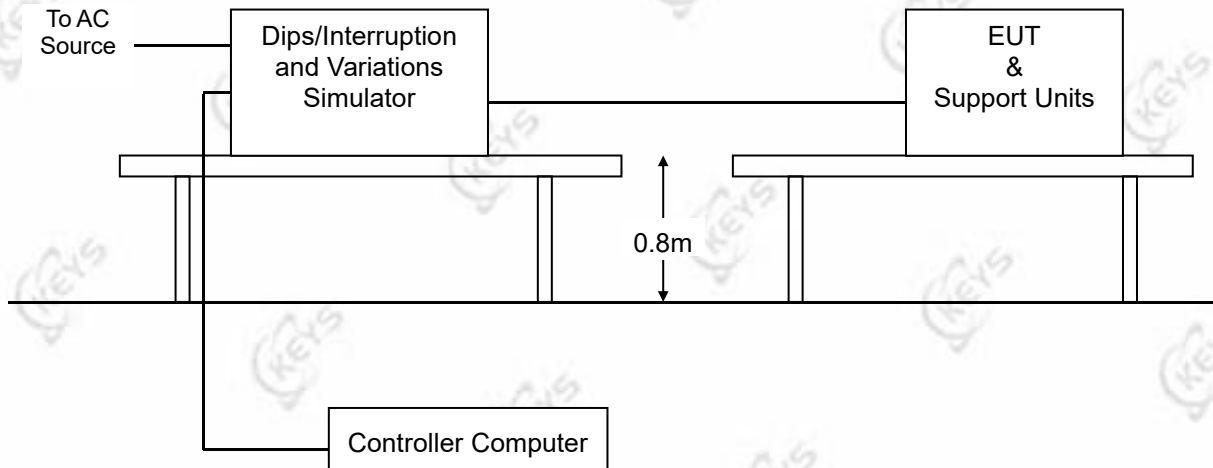

For the actual test configuration, please refer to the related item – Photographs of the Test Configuration.

# Test Report

Report No.: RKEYS250731242

Date: Aug.13, 2025

Page 50 of 55

## 8.7.4. TEST RESULT

N/A

# Test Report

Report No.: RKEYS250731242

Date: Aug.13, 2025

Page 51 of 55

## 9. PHOTOGRAPHS OF THE TEST CONFIGURATION

RADIATED EMISSION TEST(Below 1G)

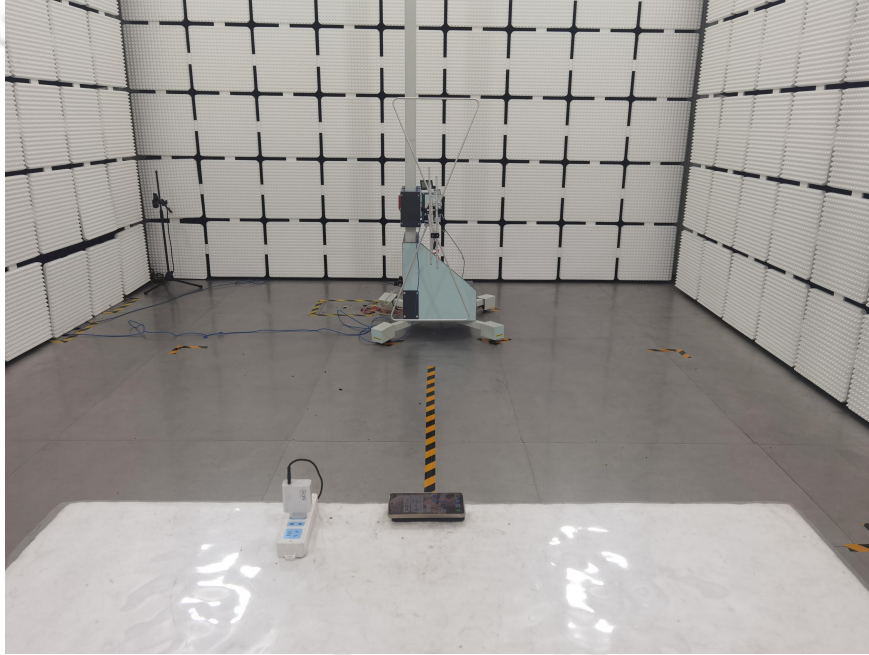

RADIATED EMISSION TEST(Above 1G)

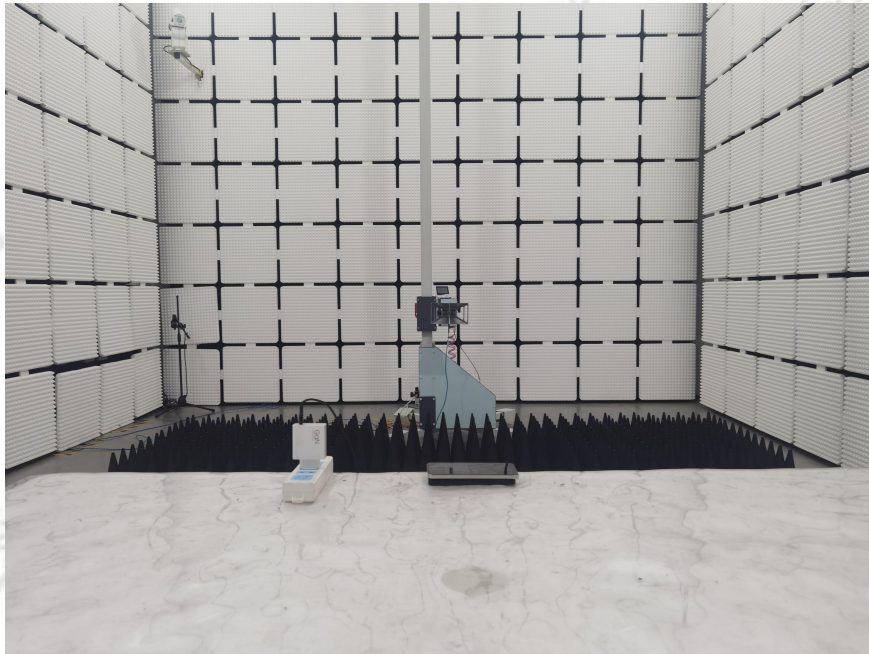

# Test Report

Report No.: RKEYS250731242

Date: Aug.13, 2025

Page 52 of 55

## ESD TEST

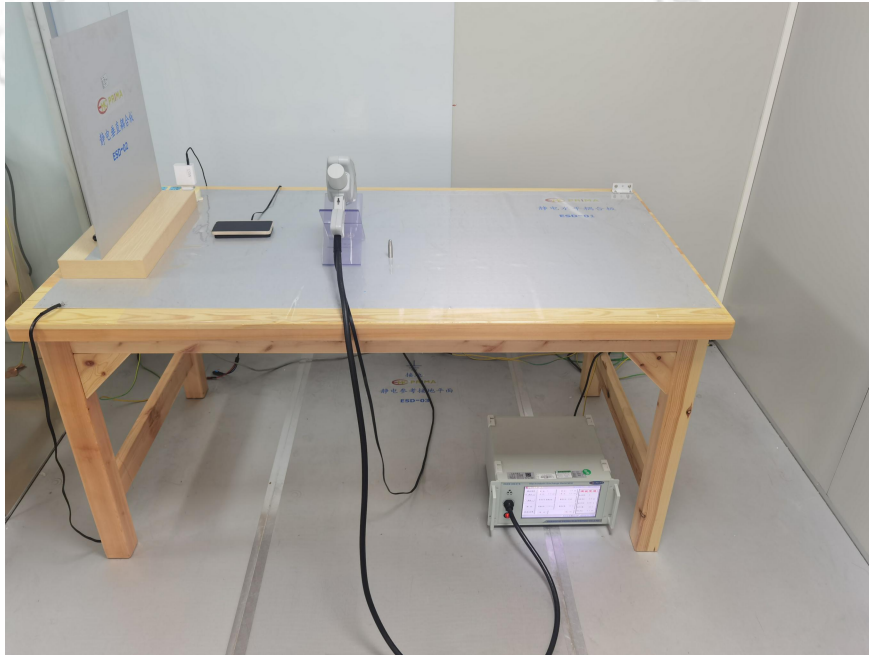

## CONDUCTION TEST



# Test Report

Report No.: RKEYS250731242

Date: Aug.13, 2025

Page 53 of 55

## 10. PHOTOGRAPHS OF EUT



# Test Report

Report No.: RKEYS250731242

Date: Aug.13, 2025

Page 54 of 55

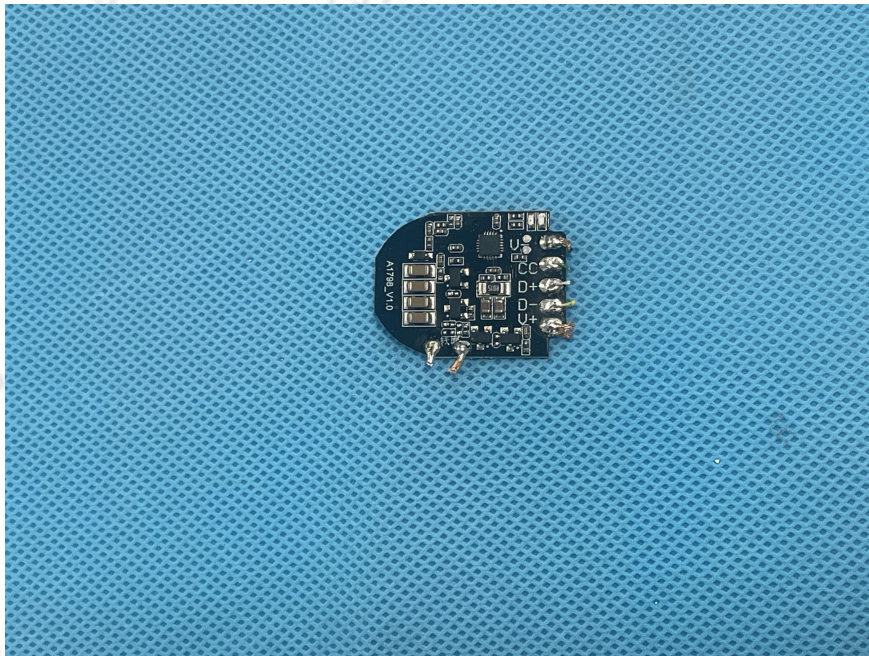
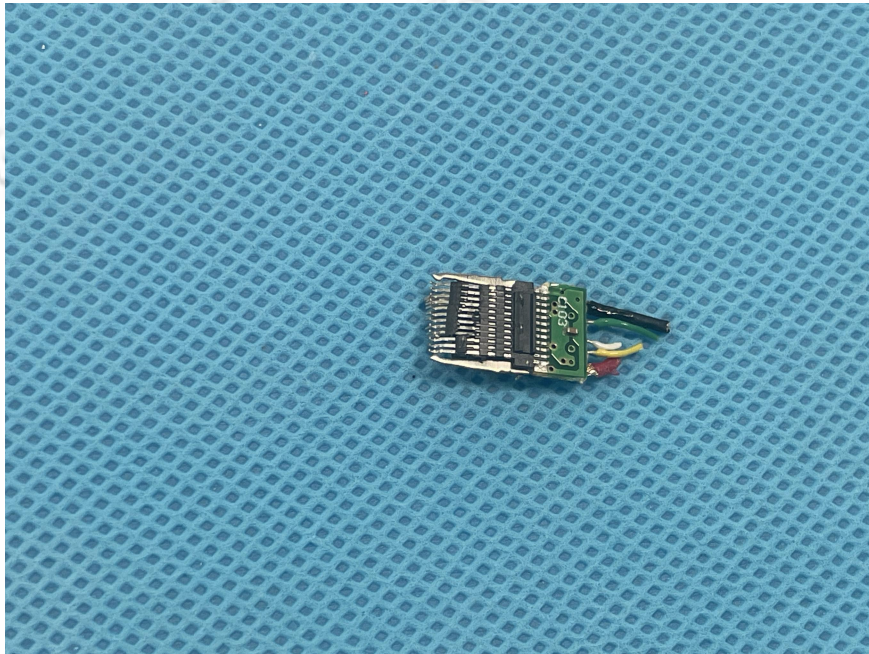

# Test Report

Report No.: RKEYS250731242

Date: Aug.13, 2025

Page 55 of 55

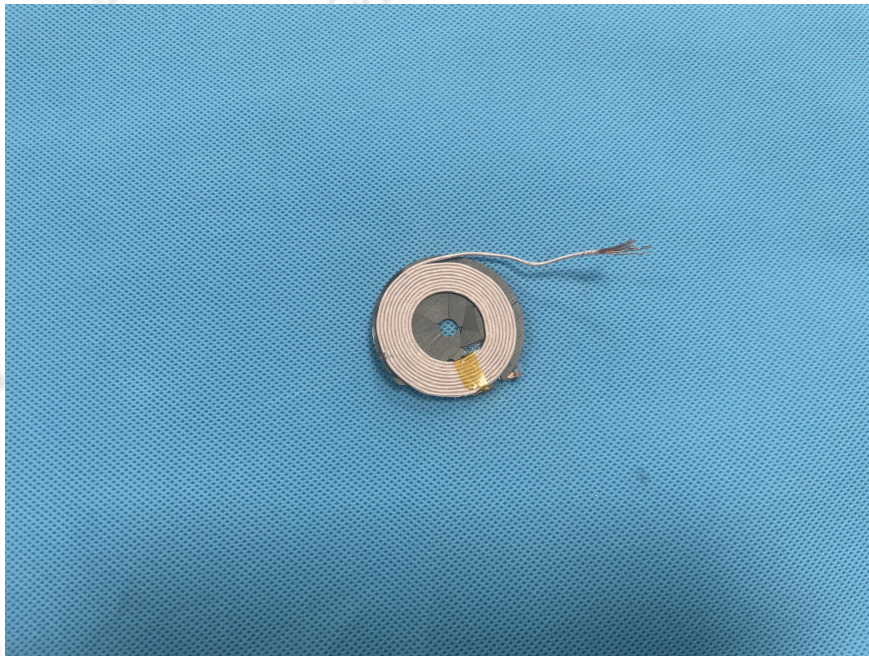
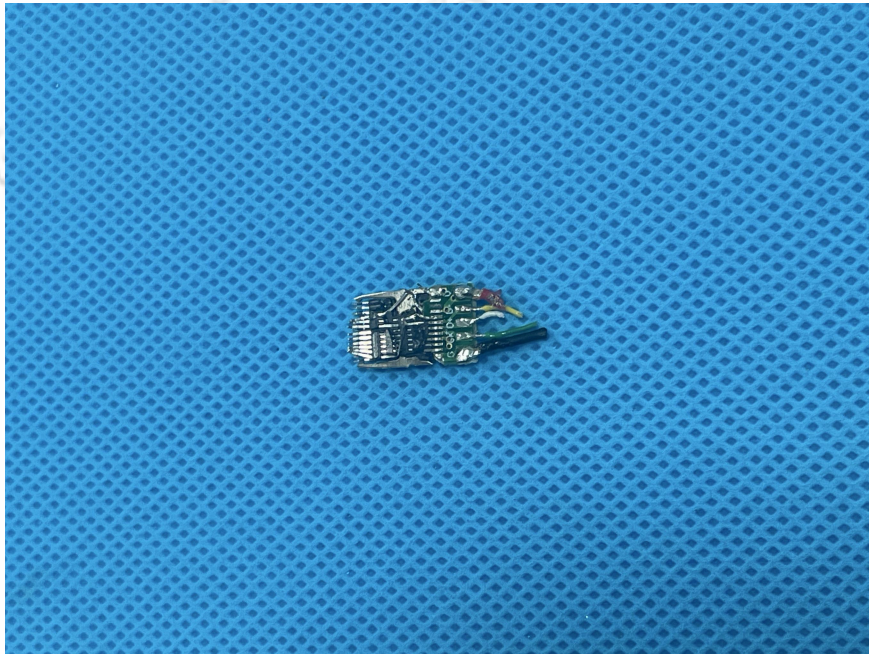

\*\*\* End of Report \*\*\*