



# Test Report

Report No.: DSP23120574-1

Date: Dec 13, 2023

Page 1 of 3

Applicant :

Address :

Manufacturer :

Address :

Sample Name : Li-ion Battery

Sample Model : 503035

Series Models : 602030, 602040, 402030, 902030, 401020, 603048, 601040, 502030, 603040, 401012, 501012, 350926, 702025, 400909, 803040, 523450, 103040, 701535, 701230, 601230, 701435, 450912, 702030, 802030, 802040, 502035.

Receiving Date : Dec 11, 2023

Testing Period : Dec 11, 2023 to Dec 13, 2023

Test Requested : To determine Lead (Pb), Cadmium (Cd), Mercury (Hg) content in accordance with the regulation (EU) 2023/1542.

Test Methods : With reference to IEC 62321-4:2013/AMD 1:2017 and IEC 62321-5:2013, analysis was performed by ICP-OES.

Test Results : Please refer to next page(s)

Conclusion :

Heavy Metal Test for Battery - according to Annex I of Regulation (EU) 2023/1542	PASS
--	------



Edited by: Python Zeng

Reviewed by: Camile Li

Approved by: Terry Cao

**Dongguan ZRLK Testing Technology Co., Ltd.**

Address: Building 2, No. 1, Technology 10th Road, Songshan Lake Park, Dongguan City, Guangdong Province.

Telephone: +86-0769-26621775-8002 Email: terry@zrlklab.com Website: www.zrlklab.com





# Test Report

Report No.: DSP23120574-1

Date: Dec 13, 2023

Page 2 of 3

## Test Results

Test Items	Regulatory requirement (%)		Results (%)	MDL (%)
	Maximum Permissible Limit	Labelling Limit		
Lead (Pb)	0.01	0.004	ND	0.0002
Cadmium (Cd)	0.002	0.002	ND	0.0002
Mercury (Hg)	0.0005	NA	ND	0.0002

Note :

1. MDL = Method detection limit.
2. ND = Not detected (lower than MDL).
3. NA = Not applicable
4. The whole battery was tested together.
5. According to Article 6 (1) and Annex I of the Regulation (EU) 2023/1542, the Lead restriction shall apply to portable batteries and portable zinc-air button cells from 18 August 2024 and 18 August 2028 respectively.
6. According to Article 13(4) and 13 (5) of the Regulation (EU) 2023/1542, all batteries shall be marked with the symbol indicating separate collection, and all batteries containing more than 0.002% cadmium or more than 0.004% lead shall be marked with the chemical symbol for the metal concerned.

**Dongguan ZRLK Testing Technology Co., Ltd.**

Address: Building 2, No. 1, Technology 10th Road, Songshan Lake Park, Dongguan City, Guangdong Province.

Telephone: +86-0769-26621775-8002 Email: [terry@zrlklab.com](mailto:terry@zrlklab.com) Website: [www.zrlklab.com](http://www.zrlklab.com)



## Test Report

Report No.: DSP23120574-1

Date: Dec 13, 2023

Page 3 of 3

### Sample Photo(s)

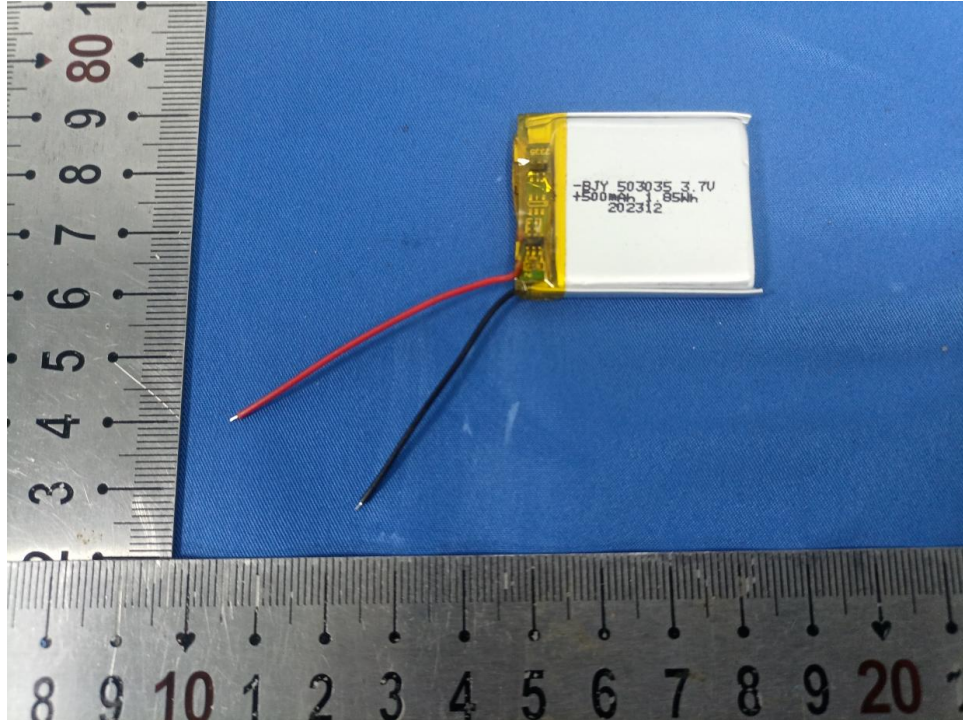

### Statement

1. Report is invalid without the editor, the reviewer or the approver signature, or altered, or additions and deletions, or not stamped with a special seal.
2. This test report is only responsible for the sample of this acceptance.
3. If the applicant does not raise any objection within 15 working days after receiving the report, it shall deemed to approve the report result.

\* \* \* End of report \* \* \*

**Dongguan ZRLK Testing Technology Co., Ltd.**

Address: Building 2, No. 1, Technology 10th Road, Songshan Lake Park, Dongguan City, Guangdong Province.

Telephone: +86-0769-26621775-8002 Email: [terry@zrlklab.com](mailto:terry@zrlklab.com) Website: [www.zrlklab.com](http://www.zrlklab.com)



**TEST REPORT  
IEC 62133-2**

**Secondary cells and batteries containing alkaline or other non-acid electrolytes – Safety requirements for portable sealed secondary cells, and for batteries made from them, for use in portable applications –  
Part 2: Lithium systems**

Report reference No. ....: DSP24070893-1

Tested by (name+ signature) .....: Vincent Huang



*Vincent Huang*

Compiled by (name+ signature) .....: Fiona Lu

*Fiona Lu*

Approved by (name+ signature) .....: Ailis Ma

*Ailis Ma*

Date of issue .....: 2024-08-15

Total number of pages .....: 26 Pages.

**Name of Testing Laboratory preparing the Report** .....: Dongguan ZRLK Testing Technology Co., Ltd.  
Building 2, No.1, Technology 10th Road, Songshan Lake Park,  
Dongguan, Guangdong, China

**Applicant's name** .....:  
Address .....

**Manufacturer's name** .....:  
Address .....

**Test specification** .....

Standard.....: IEC 62133-2:2017/AMD1:2021

Test procedure .....: Type approved

Procedure deviation .....: N/A

Non-standard test method .....: N/A

**This test report is specially limited to the above client company and product model only, It may not be duplicated without prior written consent of Dongguan ZRLK Testing Technology Co., Ltd.**

**Test item description** .....: Polymer lithium ion battery

**Trade Mark** .....: N/A

**Model/type reference** .....: 602040

**Ratings** .....: 3.7V, 400mAh, 1.48Wh



**Particulars: test item vs. test requirements**

Classification of installation and use ..... : To be defined in final product

Supply connection ..... : DC lead wire

Discharge current (0,2 It A) ..... : 80mA

Upper limit charging voltage per cell..... : 4.25V

Charging temperature upper limit..... : 45°C

Charging temperature lower limit..... : 0°C

Shape of Cell ..... :  Prismatic  
 Pouch  
 Coin/button  
 Cylindrical  
 gel polymer

Polymer cell electrolyte type..... :  solid polymer  
 Other

**Possible test case verdicts:**

- test case does not apply to the test object ..... : N/A

- test object does meet the requirement ..... : P(ass)

- test object does not meet the requirement ..... : F(ail)

**Testing:**

Date of receipt of test item ..... : 2024-07-29

Date(s) of performance of test ..... : 2024-07-29 to 2024-08-09

**General remarks:**

“(see remark #)” refers to a remark appended to the report,  
“(see appended table)” refers to a table appended to the report,  
Throughout this report a comma is used as the decimal separator,  
The test results presented in this report relate only to the object tested,  
This report shall not be reproduced except in full without the written approval of the testing laboratory,  
Clause numbers between brackets refer to clauses in IEC 62133-2:2017/AMD1:2021 (Optional remark).

Name and address of factory (ies) ..... :

**General product information:**

The Polymer lithium ion battery is constructed with one Polymer lithium ion Cell, and has overcharge, over-discharge, over current and short-circuits protection circuit.

The cells have been tested and evaluated according to their specified working conditions (as given below), which are provided by client;

Details information of the battery and the cell built in the battery, as following:

Product	Polymer lithium ion Cell	Polymer lithium ion battery
Model No.	602040	602040
Nominal voltage	3.7V	3.7V

Rated capacity	400mAh	400mAh
Recommend charging method declared by the manufacturer	Charging the cell with 0.5C (200mA) constant current, 4.2V constant voltage until current reaches 0.02C (8mA)	Charging the battery with 0.5C (200mA) constant current, 4.2V constant voltage until current reaches 0.02C (8mA)
Maximum charging current	400mA	400mA
Maximum discharge current	400mA	400mA
Maximum charging voltage	4.25V	4.25V
Specified final voltage	2.75V	2.75V

**Summary of testing:**
**Tests Performed (name of test and test clause):**

Tests are made with the number of samples specified in Table 1 of IEC 62133-2:2017/AMD1:2021.

Test items:

- cl.5.6.2 Design recommendation;
- cl.7.1 Charging procedure for test purposes;
- cl.7.2.1 Continuous charging at constant voltage (cells);
- cl.7.2.2 Case stress at high ambient temperature (battery);
- cl.7.3.1 External short-circuit (cell);
- cl.7.3.2 External short-circuit (battery);
- cl.7.3.3 Free fall (cell and battery);
- cl.7.3.4 Thermal abuse (cells);
- cl.7.3.5 Crush (cells);
- cl.7.3.6 Over-charging of battery;
- cl.7.3.7 Forced discharge (cells);
- cl.7.3.8 Mechanical tests (batteries);
- cl.7.3.9 Design evaluation – Forced internal short-circuit (cells);
- cl.8.2 Small cell and battery safety information.

The electrolyte type of this cell doesn't belong to polymer, and the additional test cl.7.3.9 was carried out to evaluate the cell.

**The product fulfils the requirements of EN 62133-2:2017/A1:2021**

**Test conclusion:**

The Polymer lithium ion battery submitted by are tested according to IEC 62133-2 Secondary cells and batteries containing alkaline or other non-acid electrolytes Safety requirements for portable sealed secondary cells, and for batteries made from them, for use in portable applications.

**Test result: Pass.**

**Testing location:**

Dongguan ZRLK Testing Technology Co., Ltd.  
Building 2, No.1, Technology 10th Road, Songshan Lake Park, Dongguan, Guangdong, China

**Copy of marking plate:**

The artwork below may be only a draft. The use of certification marks on a product must be authorized by the respective NCBs that own these marks.

Polymer lithium ion battery  
 602040 1ICP6/21/41 YYYMMDD  
 3.7V, 400mAh, 1.48Wh Red (+) Black (-)

Battery Label

**Caution:**

1. Keep small cells and batteries which are considered swallowable out of the reach of children
2. Swallowing may lead to burns, perforation of soft tissue, and death. Severe burns can occur within 2 h of ingestion
3. In case of ingestion of a cell or battery, seek medical assistance promptly

Caution Label

**Remark:**

1. "YYMMDD" represents the date of manufacture, "YYYY" represents the year, "MM" represents the month, "DD" represents the day.
2. Caution label will be placed on the immediate package.

**Construction:**

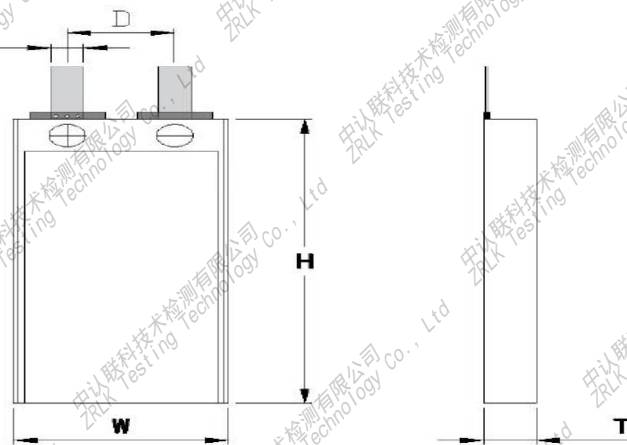

T\*W\*H=5.6 (max)\*20.5 (max)\*40.3 (max)  
 Cell (Unit: mm)

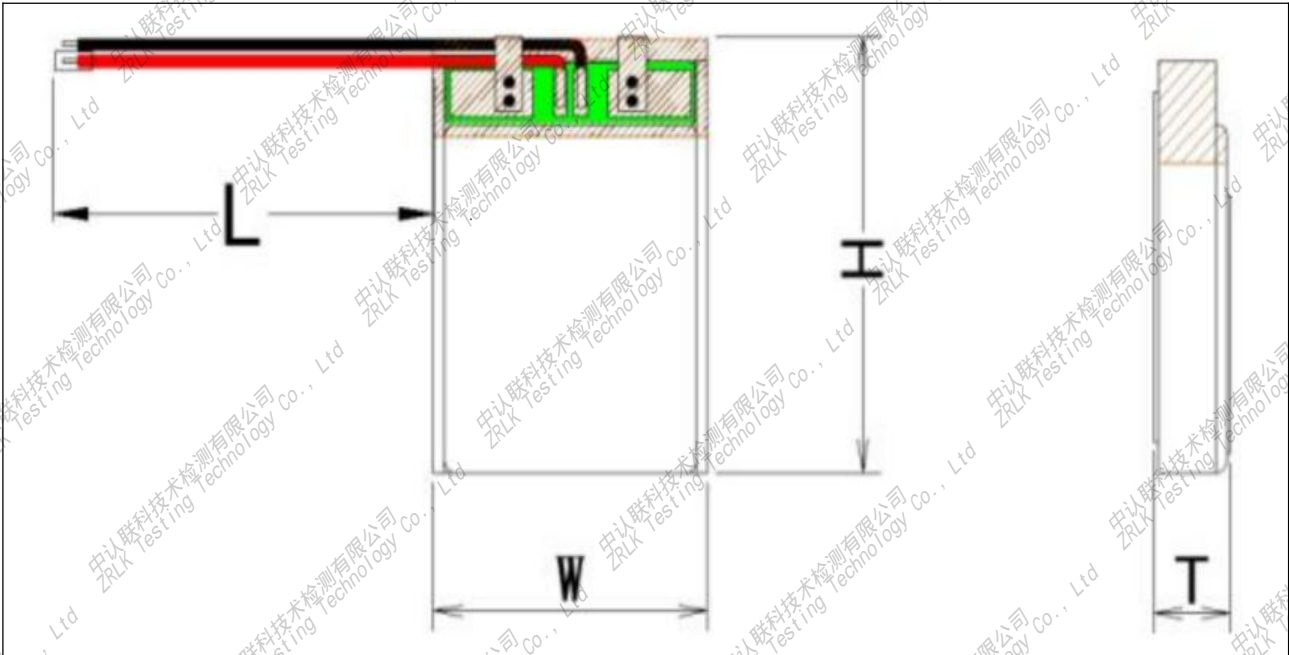

T\*W\*H=5.6 (max)\*20.5 (max)\*41.1 (max)  
Battery (Unit: mm)

**Circuit diagram:**

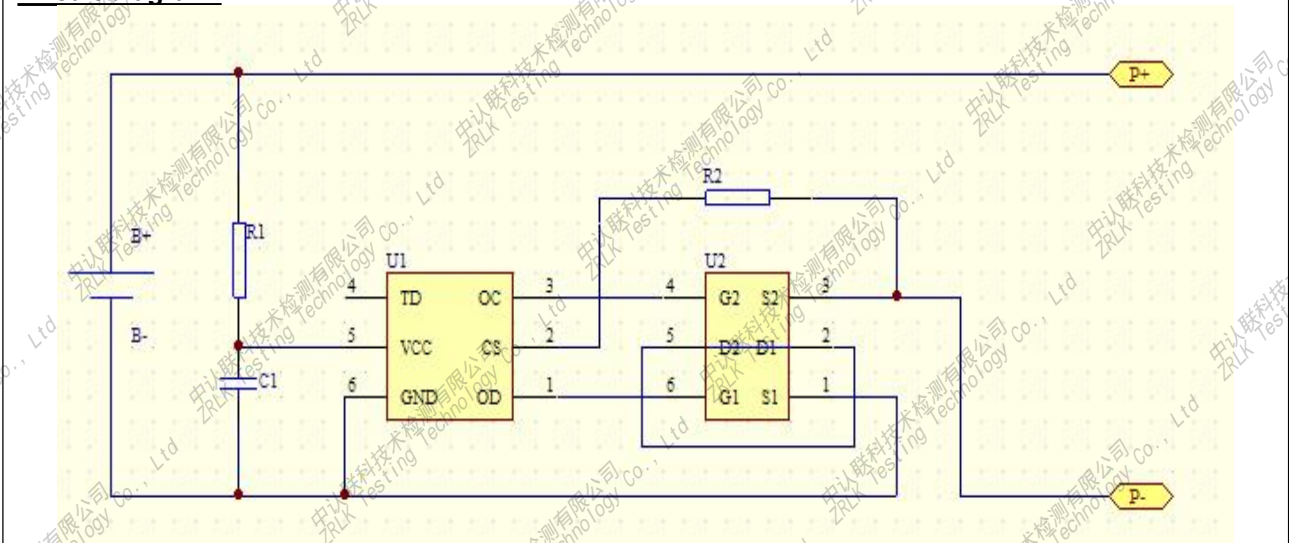





IEC 62133-2			
Clause	Requirement + Test	Result - Remark	Verdict

<b>4</b>	<b>PARAMETER MEASUREMENT TOLERANCES</b>		<b>P</b>
	Parameter measurement tolerances		<b>P</b>

<b>5</b>	<b>GENERAL SAFETY CONSIDERATIONS</b>		<b>P</b>
----------	--------------------------------------	--	----------

<b>5.1</b>	<b>General</b>		<b>P</b>
------------	----------------	--	----------

	Cells and batteries so designed and constructed that they are safe under conditions of both intended use and reasonably foreseeable misuse		<b>P</b>
--	--	--	----------

<b>5.2</b>	<b>Insulation and wiring</b>		<b>P</b>
------------	------------------------------	--	----------

	The insulation resistance between the positive terminal and externally exposed metal surfaces of the battery (excluding electrical contact surfaces) is not less than 5 MΩ	No metal surface exists.	<b>N/A</b>
--	--	--------------------------	------------

	Insulation resistance (MΩ)..... :	<b>N/A</b>	<b>—</b>
--	-----------------------------------	------------	----------

	Internal wiring and insulation are sufficient to withstand maximum anticipated current, voltage and temperature requirements		<b>P</b>
--	--	--	----------

	Orientation of wiring maintains adequate clearances and creepage distances between conductors		<b>P</b>
--	---	--	----------

	Mechanical integrity of internal connections accommodates reasonably foreseeable misuse		<b>P</b>
--	---	--	----------

<b>5.3</b>	<b>Venting</b>		<b>P</b>
------------	----------------	--	----------

	Battery cases and cells incorporate a pressure relief mechanism or are constructed so that they relieve excessive internal pressure at a value and rate that will preclude rupture, explosion and self-ignition	Venting mechanism exists on the narrow side of pouch cell.	<b>P</b>
--	---	--	----------

	Encapsulation used to support cells within an outer casing does not cause the battery to overheat during normal operation nor inhibit pressure relief		<b>N/A</b>
--	---	--	------------

<b>5.4</b>	<b>Temperature, voltage and current management</b>		<b>P</b>
------------	--	--	----------

	Batteries are designed such that abnormal temperature rise conditions are prevented	Overcharge, over discharge, over current and short-circuit proof circuit used in this battery, see tests of clause 7.	<b>P</b>
--	---	---	----------

	Batteries are designed to be within temperature, voltage and current limits specified by the cell manufacturer	See above.	<b>P</b>
--	--	------------	----------

	Batteries are provided with specifications and charging instructions for equipment manufacturers so that specified chargers are designed to maintain charging within the temperature, voltage and current limits specified	The charging limits specified in the manufacturer's specification.	<b>P</b>
--	--	--	----------

<b>5.5</b>	<b>Terminal contacts</b>		<b>P</b>
------------	--------------------------	--	----------

IEC 62133-2			
Clause	Requirement + Test	Result - Remark	Verdict
	The size and shape of the terminal contacts ensure that they can carry the maximum anticipated current	DC lead wire complied with the requirements.	P
	External terminal contact surfaces are formed from conductive materials with good mechanical strength and corrosion resistance	DC lead wire complied with the requirements.	P
	Terminal contacts are arranged to minimize the risk of short circuits		P
<b>5.6</b>	<b>Assembly of cells into batteries</b>		P
5.6.1	General		P
	Each battery has an independent control and protection for current, voltage, temperature and any other parameter required for safety and to maintain the cells within their operating region	Protective circuit equipped on battery.	P
	This protection may be provided external to the battery such as within the charger or the end devices		N/A
	If protection is external to the battery, the manufacturer of the battery provide this safety relevant information to the external device manufacturer for implementation		N/A
	If there is more than one battery housed in a single battery case, each battery has protective circuitry that can maintain the cells within their operating regions		N/A
	Manufacturers of cells specify current, voltage and temperature limits so that the battery manufacturer/designer may ensure proper design and assembly	Current, voltage and temperature limits specified by cell manufacturer.	P
	Batteries that are designed for the selective discharge of a portion of their series connected cells incorporate circuitry to prevent operation of cells outside the limits specified by the cell manufacturer		N/A
	Protective circuit components are added as appropriate and consideration given to the end-device application		P
	The manufacturer of the battery provide a safety analysis of the battery safety circuitry with a test report including a fault analysis of the protection circuit under both charging and discharging conditions confirming the compliance	Safety analysis report provided by manufacturer.	P
5.6.2	Design recommendation		P
	For the battery consisting of a single cell or a single cellblock, it is recommended that the charging voltage of the cell does not exceed the upper limit of the charging voltage specified in Table 2	Charging voltage of cell: 4.25V, not exceed 4.25V specified in Clause 7.1.2, Table 2.	P

IEC 62133-2			
Clause	Requirement + Test	Result - Remark	Verdict
	For the battery consisting of series-connected plural single cells or series-connected plural cellblocks, it is recommended that the voltages of any one of the single cells or single cellblocks does not exceed the upper limit of the charging voltage, specified in Table 2, by monitoring the voltage of every single cell or the single cellblocks		N/A
	For the battery consisting of series-connected plural single cells or series-connected plural cellblocks, it is recommended that charging is stopped when the upper limit of the charging voltage is exceeded for any one of the single cells or single cellblocks by measuring the voltage of every single cell or the single cellblocks		N/A
	For batteries consisting of series-connected cells or cell blocks, nominal charge voltage are not counted as an overcharge protection		N/A
	For batteries consisting of series-connected cells or cell blocks, cells have closely matched capacities, be of the same design, be of the same chemistry and be from the same manufacturer		N/A
	It is recommended that the cells and cell blocks are not discharged beyond the cell manufacturer's specified final voltage	Final voltage of battery: 2.75V, not exceed the final voltage specified by cell manufacturer.	P
	For batteries consisting of series-connected cells or cell blocks, cell balancing circuitry are incorporated into the battery management system		N/A
5.6.3	Mechanical protection for cells and components of batteries		P
	Mechanical protection for cells, cell connections and control circuits within the battery are provided to prevent damage as a result of intended use and reasonably foreseeable misuse	Mechanical protection for cell connections and control circuits provided.	P
	The mechanical protection can be provided by the battery case or it can be provided by the end product enclosure for those batteries intended for building into an end product	Build-in batteries, mechanical protection should be provided by end product.	P
	The battery case and compartments housing cells are designed to accommodate cell dimensional tolerances during charging and discharging as recommended by the cell manufacturer	To be evaluated in final system.	N/A
	For batteries intended for building into a portable end product, testing with the battery installed within the end product is considered when conducting mechanical tests		N/A
5.7	<b>Quality plan</b>	Complied.	P

IEC 62133-2			
Clause	Requirement + Test	Result - Remark	Verdict
	The manufacturer prepares and implements a quality plan that defines procedures for the inspection of materials, components, cells and batteries and which covers the whole process of producing each type of cell or battery	Quality plan provided.	P
<b>5.8</b>	<b>Battery safety components</b>		N/A

<b>6</b>	<b>TYPE TEST AND SAMPLE SIZE</b>		P
	Tests are made with the number of cells or batteries specified in Table 1 using cells or batteries that are not more than six months old		P
	The internal resistance of coin cells are measured in accordance with Annex D. Coin cells with internal resistance less than or equal to 3 $\Omega$ are tested in accordance with Table 1	Not coin cells	N/A
	Unless otherwise specified, tests are carried out in an ambient temperature of 20 °C $\pm$ 5 °C		P
	The safety analysis of 5.6.1 identify those components of the protection circuit that are critical for short-circuit, overcharge and over discharge protection		P
	When conducting the short-circuit test, consideration is given to the simulation of any single fault condition that is likely to occur in the protecting circuit that would affect the short-circuit test	See clause 7.3.2.	P

<b>7</b>	<b>SPECIFIC REQUIREMENTS AND TESTS</b>		P
<b>7.1</b>	<b>Charging procedure for test purposes</b>		P
7.1.1	First procedure		P
	This charging procedure applies to subclauses other than those specified in 7.1.2		P
	Unless otherwise stated in this document, the charging procedure for test purposes is carried out in an ambient temperature of 20 °C $\pm$ 5 °C, using the method declared by the manufacturer		P
	Prior to charging, the battery has been discharged at 20 °C $\pm$ 5 °C at a constant current of 0,2 It A down to a specified final voltage		P
7.1.2	Second procedure		P
	This charging procedure applies only to 7.3.1, 7.3.4, 7.3.5, and 7.3.9		P

IEC 62133-2			
Clause	Requirement + Test	Result - Remark	Verdict
	After stabilization for 1 h to 4 h, at an ambient temperature of the highest test temperature and the lowest test temperature, respectively, as specified in Table 2, cells are charged by using the upper limit charging voltage and maximum charging current, until the charging current is reduced to 0,05 It A, using a constant current to constant voltage charging method	Charge temperature 0-45°C declared; 45°C used for upper limit test temperature; 0°C used for lower limit test temperature.	P
<b>7.2</b>	<b>Intended use</b>		P
7.2.1	Continuous charging at constant voltage (cells)	Tested complied.	P
	Fully charged cells are subjected for 7 days to a charge using the charging method for current and standard voltage specified by the cell manufacturer	Charging for 7 days with 200mA and 4.20V.	P
	Results: no fire, no explosion, no leakage.....	(See appended table 7.2.1)	P
7.2.2	Case stress at high ambient temperature (battery)	Tested as client requested.	P
	Oven temperature (°C).....	70	—
	Results: no physical distortion of the battery case resulting in exposure of internal protective components and cells	No physical distortion of the battery.	P
<b>7.3</b>	<b>Reasonably foreseeable misuse</b>		P
7.3.1	External short-circuit (cell)	Tested complied.	P
	The cells were tested until one of the following occurred:		P
	- 24 hours elapsed; or		N/A
	- The case temperature declined by 20 % of the maximum temperature rise		P
	Results: no fire, no explosion.....	(See appended table 7.3.1)	P
7.3.2	External short-circuit (battery)	Tested complied.	P
	The batteries were tested until one of the following occurred:		P
	- 24 hours elapsed; or		N/A
	- The case temperature declined by 20 % of the maximum temperature rise		P
	In case of rapid decline in short circuit current, the battery pack remained on test for an additional one hour after the current reached a low end steady state condition		P
	A single fault in the discharge protection circuit is conducted on one to four (depending upon the protection circuit) of the five samples before conducting the short-circuit test	Shorting single fault conducted on two samples.	P

IEC 62133-2			
Clause	Requirement + Test	Result - Remark	Verdict
	A single fault applies to protective component parts such as MOSFET (metal oxide semiconductor field-effect transistor), fuse, thermostat or positive temperature coefficient (PTC) thermistor	Single fault applies to MOSFET U2 (Pin1-Pin3).	P
	Results: no fire, no explosion.....:	(See appended table 7.3.2)	P
7.3.3	Free fall	Tested complied.	P
	Results: no fire, no explosion	No fire. No explosion	P
7.3.4	Thermal abuse (cells)	Tested complied.	P
	Oven temperature (°C).....:	130	—
	Results: no fire, no explosion	No fire. No explosion	P
7.3.5	Crush (cells)	Tested complied.	P
	The crushing force was released upon:		P
	- The maximum force of 13 kN ± 0,78 kN has been applied; or		P
	- An abrupt voltage drop of one-third of the original voltage has been obtained		N/A
	Results: no fire, no explosion.....:	(See appended table 7.3.5)	P
7.3.6	Over-charging of battery		P
	The supply voltage which is:		P
	- 1.4 times the upper limit charging voltage presented in Table A.1 (but not to exceed 6,0 V) for single cell/cell block batteries or	5.95V applied.	P
	- 1,2 times the upper limit charging voltage resented in Table A.1 per cell for series connected multi-cell batteries, and		N/A
	- Sufficient to maintain a current of 2,0 It A throughout the duration of the test or until the supply voltage is reached	0.8A applied.	P
	Test was continued until the temperature of the outer casing:		P
	- Reached steady state conditions (less than 10 °C change in 30-minute period); or		N/A
	- Returned to ambient		P
	Results: no fire, no explosion.....:	(See appended table 7.3.6)	P
7.3.7	Forced discharge (cells)	Tested complied.	P
	Discharge a single cell to the lower limit discharge voltage specified by the cell manufacturer		P
	The discharged cell is then subjected to a forced discharge at 1 It A to the negative value of the upper limit charging voltage		P

IEC 62133-2			
Clause	Requirement + Test	Result - Remark	Verdict
	- The discharge voltage reaches the negative value of upper limit charging voltage within the testing duration. The voltage is maintained at the negative value of the upper limit charging voltage by reducing the current for the remainder of the testing duration		N/A
	- The discharge voltage does not reach the negative value of upper limit charging voltage within the testing duration. The test is terminated at the end of the testing duration		P
	Results: no fire, no explosion.....	(See appended table 7.3.7)	P
7.3.8	Mechanical tests (batteries)		P
7.3.8.1	Vibration	Tested complied.	P
	Results: no fire, no explosion, no rupture, no leakage or venting.....	(See appended table 7.3.8.1)	P
7.3.8.2	Mechanical shock	Tested complied.	P
	Results: no leakage, no venting, no rupture, no explosion and no fire.....	(See appended table 7.3.8.2)	P
7.3.9	Design evaluation – Forced internal short-circuit (cells)	Tested complied.	P
	The cells complied with national requirement for.....	France, Japan, Republic of Korea and Switzerland	—
	The pressing was stopped upon:		P
	- A voltage drop of 50 mV has been detected; or		N/A
	- The pressing force of 800 N (cylindrical cells) or 400 N (prismatic cells) has been reached	400 N for prismatic cells	P
	Results: no fire.....	(See appended table 7.3.9)	P
<b>8</b>	<b>INFORMATION FOR SAFETY</b>		<b>P</b>
<b>8.1</b>	<b>General</b>		<b>P</b>
	Manufacturers of secondary cells provides information about current, voltage and temperature limits of their products	Information for safety mentioned in manufacturer's specifications.	P
	Manufacturers of batteries provides information regarding how to minimize and mitigate hazards to equipment manufacturers or end-users	Information for safety mentioned in manufacturer's specifications.	P
	Systems analyses are performed by device manufacturers to ensure that a particular battery design prevents hazards from occurring during use of a product		N/A
	As appropriate, any information relating to hazard avoidance resulting from a system analysis is provided to the end user		N/A
	Do not allow children to replace batteries without adult supervision		N/A

IEC 62133-2			
Clause	Requirement + Test	Result - Remark	Verdict

<b>8.2</b>	<b>Small cell and battery safety information</b>	Small cell and battery.	P
	The following warning language is to be provided with the information packaged with the small cells and batteries or equipment using them:	See marking plate on page 4.	P
	- Keep small cells and batteries which are considered swallowable out of the reach of children		P
	- Swallowing may lead to burns, perforation of soft tissue, and death. Severe burns can occur within 2 h of ingestion		P
	- In case of ingestion of a cell or battery, seek medical assistance promptly		P

<b>9</b>	<b>MARKING</b>		P
<b>9.1</b>	<b>Cell marking</b>	The final product is battery	N/A
	Cells are marked as specified in IEC 61960, except coin cells		N/A
	Coin cells whose external surface area is too small to accommodate the markings on the cells show the designation and polarity		N/A
	By agreement between the cell manufacturer and the battery and/or end product manufacturer, component cells used in the manufacture of a battery need not be marked		N/A
<b>9.2</b>	<b>Battery marking</b>		P
	Batteries are marked as specified in IEC 61960, except for coin batteries	See marking plate on page 4.	P
	Coin batteries whose external surface area is too small to accommodate the markings on the batteries show the designation and polarity	Not coin battery	N/A
	Batteries are marked with an appropriate caution statement	Batteries also marked with an appropriate caution statement	P
	- Terminals have clear polarity marking on the external surface of the battery, or	Polarity marked on the surface of battery, also see marking plate on page 4.	P
	- Not be marked with polarity markings if the design of the external connector prevents reverse polarity connections		N/A
<b>9.3</b>	<b>Caution for ingestion of small cells and batteries</b>		N/A
	Coin cells and batteries identified as small batteries include a caution statement regarding the hazards of ingestion in accordance with 8.2	Not coin cells and batteries	N/A
	Small cells and batteries are intended for direct sale in consumer-replaceable applications, caution for ingestion is given on the immediate package	Not direct sale battery.	N/A





IEC 62133-2			
Clause	Requirement + Test	Result - Remark	Verdict

<b>9.4</b>	<b>Other information</b>		P
	The following information are marked on or supplied with the battery:		P
	- Storage and disposal instructions	Information for storage and disposal instructions mentioned in manufacturer's specifications.	P
	- Recommended charging instructions	Information for recommended charging instructions mentioned in manufacturer's specifications.	P

<b>10</b>	<b>PACKAGING AND TRANSPORT</b>		N/A
	Packaging for coin cells are not be small enough to fit within the limits of the ingestion gauge of Figure 3	Not coin cells.	N/A

<b>ANNEX A</b>	<b>CHARGING AND DISCHARGING RANGE OF SECONDARY LITHIUM ION CELLS FOR SAFE USE</b>		P
<b>A.1</b>	<b>General</b>		P
<b>A.2</b>	<b>Safety of lithium ion secondary battery</b>	Complied	P
<b>A.3</b>	<b>Consideration on charging voltage</b>	Complied	P
A.3.1	General		P
A.3.2	Upper limit charging voltage	4.25V	P
A.3.2.1	General		P
A.3.2.2	Explanation of safety viewpoint		N/A
A.3.2.3	Safety requirements, when different upper limit charging voltage is applied	4.25V applied.	N/A
<b>A.4</b>	<b>Consideration of temperature and charging current</b>		P
A.4.1	General		P
A.4.2	Recommended temperature range	See A.4.2.2.	P
A.4.2.1	General		P
A.4.2.2	Safety consideration when a different recommended temperature range is applied	Charging temperature declared by client is: 0-45°C	P
A.4.3	High temperature range	Not higher than the temperature range specific in this standard.	N/A
A.4.3.1	General		N/A
A.4.3.2	Explanation of safety viewpoint		N/A
A.4.3.3	Safety considerations when specifying charging conditions in the high temperature range	45°C applied	N/A

IEC 62133-2			
Clause	Requirement + Test	Result - Remark	Verdict
A.4.3.4	Safety considerations when specifying a new upper limit in the high temperature range		N/A
A.4.4	Low temperature range	Charging low temperature declared by client is: 0°C.	P
A.4.4.1	General		P
A.4.4.2	Explanation of safety viewpoint		P
A.4.4.3	Safety considerations, when specifying charging conditions in the low temperature range	0°C applied	P
A.4.4.4	Safety considerations when specifying a new lower limit in the low temperature range	No documents provided by manufacturer explaining the lower limit exceed 10°C, 0°C applied for testing in this report for safety considerations.	P
A.4.5	Scope of the application of charging current		P
A.4.6	Consideration of discharge		P
A.4.6.1	General		P
A.4.6.2	Final discharge voltage and explanation of safety viewpoint	Cell specified final voltage 2.75V.	P
A.4.6.3	Discharge current and temperature range		P
A.4.6.4	Scope of application of the discharging current		P
<b>A.5</b>	<b>Sample preparation</b>		P
A.5.1	General		P
A.5.2	Insertion procedure for nickel particle to generate internal short		P
A.5.3	Disassembly of charged cell		P
A.5.4	Shape of nickel particle		P
A.5.5	Insertion of nickel particle in cylindrical cell		N/A
A.5.5.1	Insertion of nickel particle in winding core		N/A
A.5.5.2	Marking the position of the nickel particle on both ends of the winding core of the separator		N/A
A.5.6	Insertion of nickel particle in prismatic cell		P
<b>A.6</b>	<b>Experimental procedure of the forced internal short-circuit test</b>		P
A.6.1	Material and tools for preparation of nickel particle		P
A.6.2	Example of a nickel particle preparation procedure		P
A.6.3	Positioning (or placement) of a nickel particle		P
A.6.4	Damaged separator precaution		P
A.6.5	Caution for rewinding separator and electrode		P
A.6.6	Insulation film for preventing short-circuit		P



IEC 62133-2			
Clause	Requirement + Test	Result - Remark	Verdict
A.6.7	Caution when disassembling a cell		P
A.6.8	Protective equipment for safety		P
A.6.9	Caution in the case of fire during disassembling		P
A.6.10	Caution for the disassembling process and pressing the electrode core		P
A.6.11	Recommended specifications for the pressing device		P
<b>ANNEX B</b>	<b>RECOMMENDATIONS TO EQUIPMENT MANUFACTURERS AND BATTERY ASSEMBLERS</b>		N/A
<b>ANNEX C</b>	<b>RECOMMENDATIONS TO THE END-USERS</b>		N/A
<b>ANNEX D</b>	<b>MEASUREMENT OF THE INTERNAL AC RESISTANCE FOR COIN CELLS</b>		N/A
<b>D.1</b>	<b>General</b>	Not coin cells	N/A
<b>D.2</b>	<b>Method</b>		N/A
	A sample size of three coin cells is required for this measurement		N/A
	Coin cells with an internal resistance greater than 3 Ω require no further testing.....	(See appended table D.2)	N/A
	Coin cells with an internal resistance less than or equal to 3 Ω are subjected to the testing according to Clause 6 and Table 1		N/A
<b>ANNEX E</b>	<b>PACKAGING AND TRANSPORT</b>		N/A
<b>ANNEX F</b>	<b>COMPONENT STANDARDS REFERENCES</b>		N/A

IEC 62133-2			
Clause	Requirement + Test	Result - Remark	Verdict

7.2.1	TABLE: Continuous charging at constant voltage (cells)				P
Sample No.	Recommended charging voltage Vc (Vdc)	Recommended charging current I <sub>rec</sub> (A)	OCV before test (Vdc)	Results	
Cell #1	4.20	0.2	4.19	P	
Cell #2	4.20	0.2	4.19	P	
Cell #3	4.20	0.2	4.19	P	
Cell #4	4.20	0.2	4.18	P	
Cell #5	4.20	0.2	4.18	P	
<b>Supplementary information:</b>					
- No fire or explosion					
- No leakage					

7.3.1	TABLE: External short circuit (cell)					P
Sample No.	Ambient (°C)	OCV at start of test (Vdc)	Resistance of circuit (mΩ)	Maximum case temperature rise ΔT (°C)	Results	
<b>Samples charged at charging temperature upper limit (45°C)</b>						
Cell 6#	57.9	4.21	85	120.8	P	
Cell 7#	57.9	4.21	79	123.6	P	
Cell 8#	57.9	4.21	83	122.3	P	
Cell 9#	57.9	4.20	81	124.5	P	
Cell 10#	57.9	4.20	76	122.8	P	
<b>Samples charged at charging temperature lower limit (0°C)</b>						
Cell 11#	57.0	4.11	78	125.8	P	
Cell 12#	57.0	4.11	80	126.7	P	
Cell 13#	57.0	4.10	84	128.6	P	
Cell 14#	57.0	4.10	77	127.5	P	
Cell 15#	57.0	4.11	82	128.4	P	
<b>Supplementary information:</b>						
- No fire or explosion						

IEC 62133-2			
Clause	Requirement + Test	Result - Remark	Verdict

7.3.2	TABLE: External short circuit (battery)					P
Sample No.	Ambient T (°C)	OCV before test (Vdc)	Resistance of circuit (mΩ)	Maximum case temperature rise $\Delta T$ (°C)	Component single fault condition	Results
Battery 4#	22.8	4.19	88	120.0	MOSFET U2 (Pin1-Pin3) S-C	P
Battery 5#	22.8	4.18	85	119.3	MOSFET U2 (Pin1-Pin3) S-C	P
Battery 6#	22.8	4.19	77	23.5	--	P
Battery 7#	22.8	4.19	81	23.1	--	P
Battery 8#	22.8	4.18	84	23.3	--	P
<b>Supplementary information:</b>						
- No fire or explosion						
Remark: S-C: short circuit						

7.3.5	TABLE: Crush (cells)				P
Sample No.	OCV before test (Vdc)	OCV at removal of crushing force (Vdc)	Maximum force applied to the cell during crush (kN)	Results	
<b>Samples charged at charging temperature upper limit (45°C)</b>					
Cell 29#	4.20	4.20	13	P	
Cell 30#	4.21	4.21	13	P	
Cell 31#	4.21	4.21	13	P	
Cell 32#	4.21	4.21	13	P	
Cell 33#	4.20	4.20	13	P	
<b>Samples charged at charging temperature lower limit (0°C)</b>					
Cell 34#	4.10	4.10	13	P	
Cell 35#	4.10	4.10	13	P	
Cell 36#	4.11	4.11	13	P	
Cell 37#	4.11	4.11	13	P	
Cell 38#	4.11	4.11	13	P	
<b>Supplementary information:</b>					
- No fire or explosion					
Note: A 13kN force applied at the wide side of prismatic cells.					

IEC 62133-2			
Clause	Requirement + Test	Result - Remark	Verdict

7.3.6 TABLE: Over-charging of battery			P	
Constant charging current (A).....:		0.8	—	
Supply voltage (Vdc).....:		5.95	—	
Sample No.	OCV before charging (Vdc)	Total charging time (minute)	Maximum outer case temperature (°C)	Results
Battery 12#	3.30	62	26.0	P
Battery 13#	3.31	62	26.7	P
Battery 14#	3.34	62	27.4	P
Battery 15#	3.32	62	25.7	P
Battery 16#	3.34	62	26.5	P
<b>Supplementary information:</b>				
- No fire or explosion				

7.3.7 TABLE: Forced discharge (cells)			P	
Sample No.	OCV before application of reverse charge (Vdc)	Measured reverse charge $I_t$ (A)	Lower limit discharge voltage (Vdc)	Results
Cell 39#	3.31	0.4	2.75	P
Cell 40#	3.30	0.4	2.75	P
Cell 41#	3.31	0.4	2.75	P
Cell 42#	3.33	0.4	2.75	P
Cell 43#	3.25	0.4	2.75	P
<b>Supplementary information:</b>				
- No fire or explosion				

7.3.8.1 TABLE: Vibration			P		
Sample No.	OCV before test (Vdc)	OCV after test (Vdc)	Mass before test (g)	Mass after test (g)	Results
Battery 17#	4.19	4.17	9.0809	9.0787	P
Battery 18#	4.18	4.16	9.0249	9.0228	P
Battery 19#	4.18	4.16	9.0653	9.0633	P
<b>Supplementary information:</b>					
- No fire or explosion					
- No rupture					
- No leakage					
- No venting					

IEC 62133-2			
Clause	Requirement + Test	Result - Remark	Verdict

7.3.8.2	TABLE: Mechanical shock					P
Sample No.	OCV before test (Vdc)	OCV after test (Vdc)	Mass before test (g)	Mass after test (g)	Results	
Battery 20#	4.19	4.18	9.0723	9.0711	P	
Battery 21#	4.18	4.18	9.0848	9.0841	P	
Battery 22#	4.19	4.18	9.0791	9.0780	P	
<b>Supplementary information:</b>						
- No fire or explosion - No rupture - No leakage - No venting						

7.3.9	TABLE: Forced internal short circuit (cells)					P
Sample No.	Chamber ambient T (°C)	OCV before test (Vdc)	Particle location <sup>1)</sup>	Maximum applied pressure (N)	Results	
<b>Samples charged at charging temperature upper limit (45°C)</b>						
Cell 44#	45	4.19	1	400	P	
Cell 45#	45	4.18	1	400	P	
Cell 46#	45	4.19	1	400	P	
Cell 47#	45	4.18	1*	400	P	
Cell 48#	45	4.18	1*	400	P	
<b>Samples charged at charging temperature lower limit (0°C)</b>						
Cell 49#	0	4.09	1	400	P	
Cell 50#	0	4.08	1	400	P	
Cell 51#	0	4.07	1	400	P	
Cell 52#	0	4.08	1*	400	P	
Cell 53#	0	4.09	1*	400	P	
<b>Supplementary information:</b>						
<sup>1)</sup> Identify one of the following: 1: Nickel particle inserted between positive and negative (active material) coated area. 2: Nickel particle inserted between positive aluminium foil and negative active material coated area. *: No location 2 exist. - No fire						



IEC 62133-2			
Clause	Requirement + Test	Result - Remark	Verdict

<b>D.2</b>	<b>TABLE: Internal AC resistance for coin cells</b>			<b>N/A</b>
Sample no.	Ambient T (°C)	Store time (h)	Resistance Rac (Ω)	Results <sup>1)</sup>
--	--	--	--	--
--	--	--	--	--
--	--	--	--	--

**Supplementary information:**

<sup>1)</sup> Coin cells with an internal resistance less than or equal to 3 Ω, see test result on corresponding tables according to Clause 6 and Table 1.



IEC 62133-2			
Clause	Requirement + Test	Result - Remark	Verdict

TABLE: Critical components information					P
Object / part No.	Manufacturer/ trademark	Type / model	Technical data	Standard	Mark(s) of conformity <sup>1)</sup>
Wiring	SUMITOMO ELECTRIC INDUSTRIES LTD	1571	26AWG, 80°C, 30V	--	--
Wiring (Alternative)	Interchangeable	Interchangeable	26AWG minimum, Min. 80°C, Min. 30V	--	--
PCB	Shenzhen Zhongxinda Electronics Co., LTD	ZXD-1432-16-200	130°C, Min. Thk.: 0.6mm	--	--
PCB (Alternative)	Interchangeable	Interchangeable	130°C, Min. Thk.: 0.6mm	--	--
Protect IC (U1)	ShenZhen Puolop Electronics co.,LTD.	DW01AP	Overcharge detection voltage: 4.30±0.05V, Overdischarge detection voltage: 2.40±0.10V, T <sub>opr</sub> : -40°C ~ +85°C	--	Tested with appliance
MOSFET (U2)	ShenZhen Puolop Electronics co.,LTD.	PT8205	V <sub>DS</sub> : 20V, V <sub>GS</sub> : ±12V, I <sub>D</sub> : 6A, T <sub>J</sub> : -55 to 150°C	--	Tested with appliance
Cell		602040	3.7V, 400mAh	IEC 62133-2:2017/AM D1:2021	Tested with appliance
-Electrolyte	Dongguan Shanshan battery material co. LTD	LD-134BJ	LiPF <sub>6</sub> + DC+ EMC+ EC	--	--
-Separator	SINOMA LITHIUM BATTERY SEPARATOR CO LTD	16UM	PE, 16µm (T)× 25mm (W)× 803mm (L), Shutdown temperature: 130°C	--	--
-Positive electrode	Hunan Shanshan new materials Co., Ltd.	LC0-1	LiCoO <sub>2</sub>	--	--
-Negative electrode	Shanghai Shanshan Tech.CO.,LTD	LA1	Graphite	--	--
-Aluminium plastic film	SHOWA DENKO K.K	113	Nylon, PP, Aluminum, 113µm (T)	--	--
Supplementary information:					
1) Provided evidence ensures the agreed level of compliance. See OD-CB2039.					

Model: 602040

### Photos

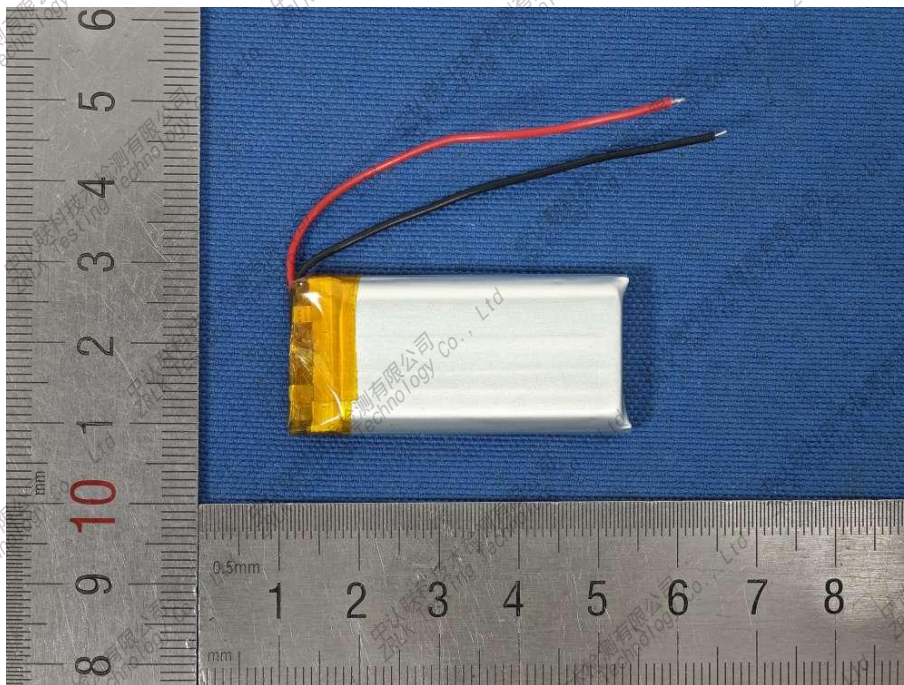
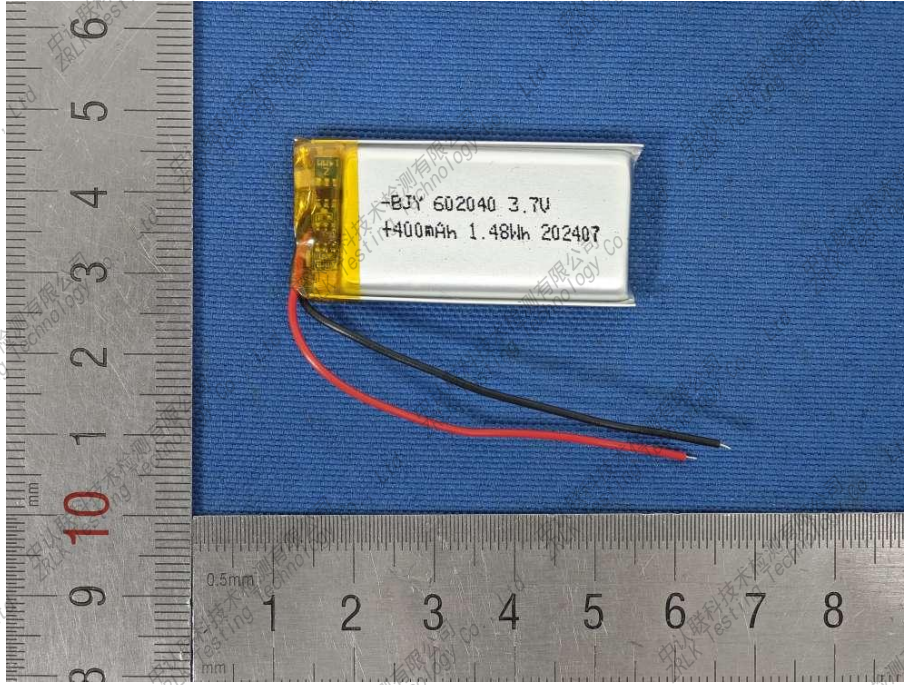

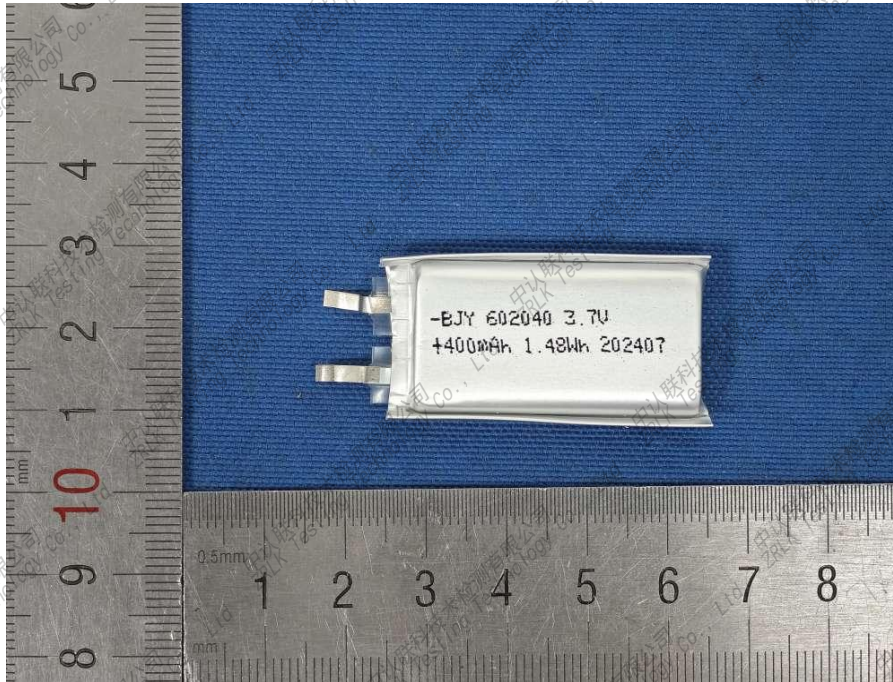
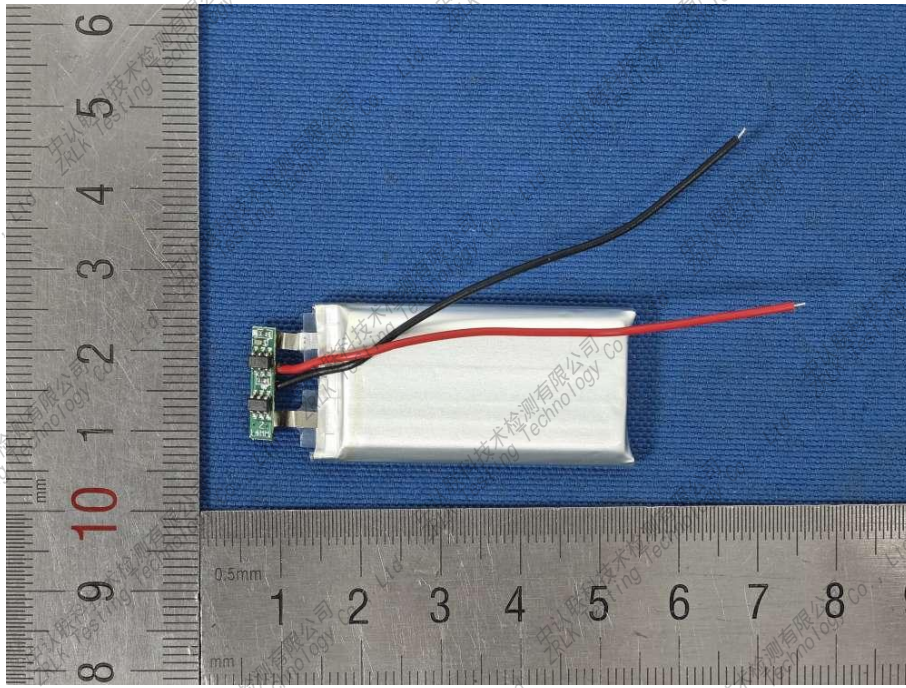

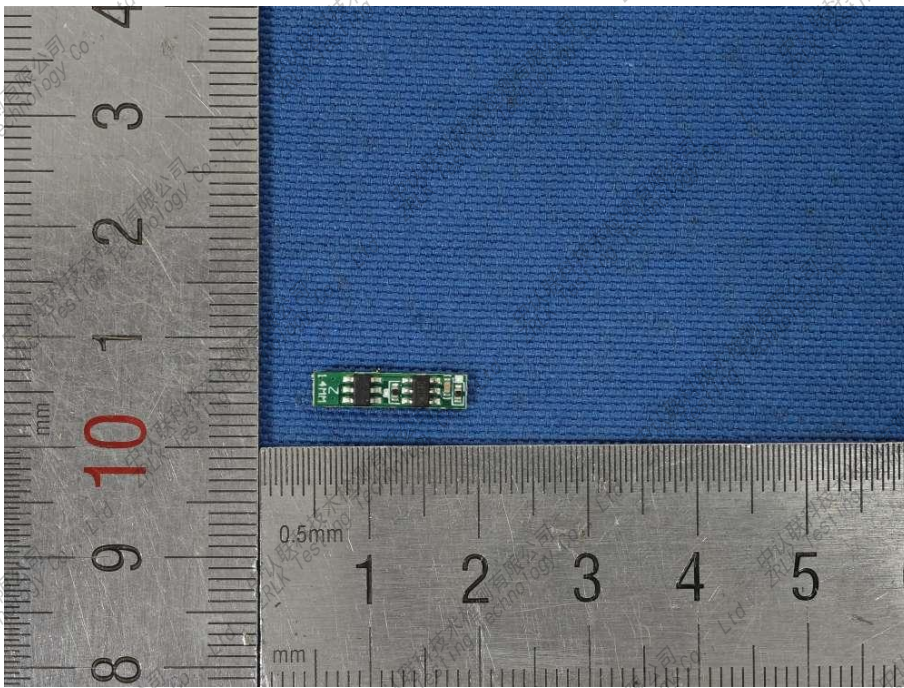
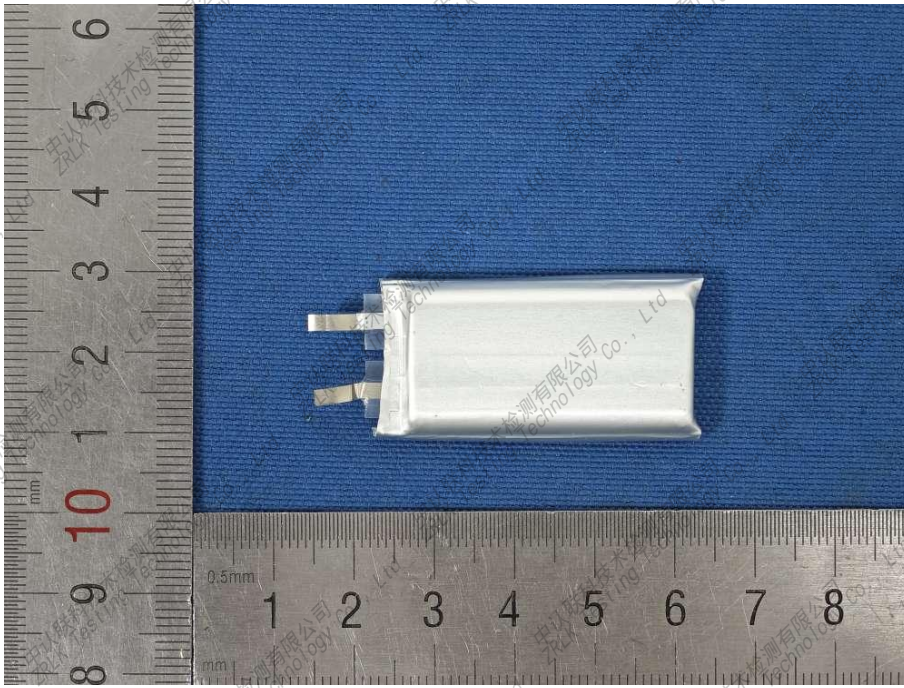

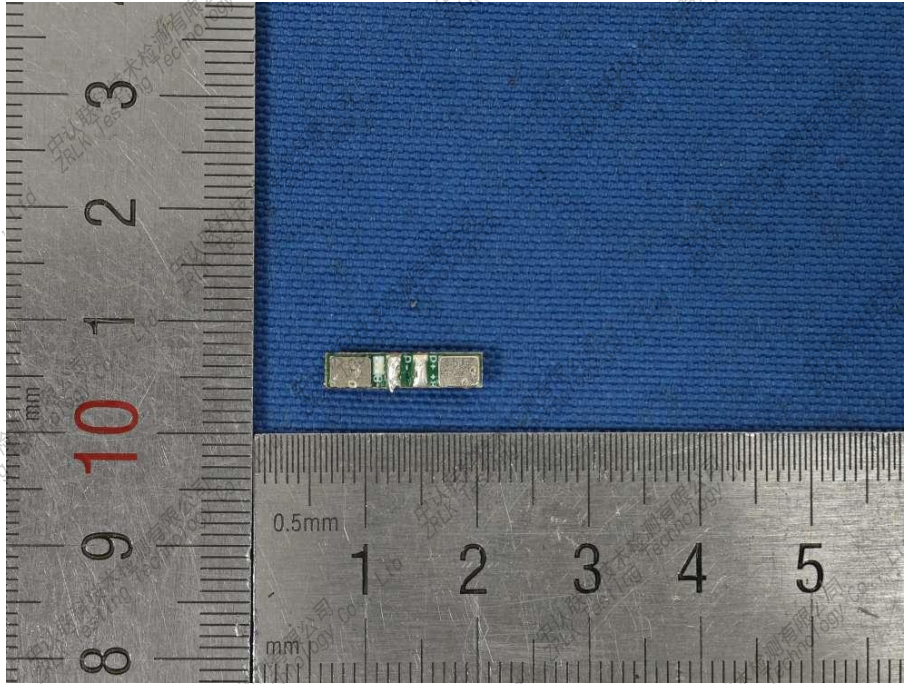

\*\*\* End of Test Report \*\*\*